

# *Firefly SDR*

## *Hendricks QRP Kits*

Software Defined Receiver for 30m and 20m  
With 2.5w/3.5w CW Transmitter

by Dan Tayloe, N7VE

Firefly SDR v7 11-8-06  
Page 1 of 74

## *Table of Contents*

Specifications .....	5
Receiver .....	5
Transmitter .....	5
Note to the Reader .....	7
Building the Kit.....	7
Things you will need.....	7
Parts List .....	10
Tools and Construction Hints .....	17
Bare PC Board Pictures .....	19
Power Connections and 5 and 6v Regulators .....	21
5 and 6v Regulator Tests.....	23
Sidetone monitor Amplifier .....	24
CW Side Tone Monitor Amplifier Test.....	26
Keyer Circuit.....	27
Keyer and CW Side Tone Monitor Amplifier Test .....	29
Receiver Side Local Oscillator .....	30
Receiver Side Local Oscillator Test .....	32
90 Degree Phasing Section and LO Buffer.....	32
90 Degree Phasing Section and LO Buffer Tests .....	34
Detector Circuit.....	34
Detector Circuit Tests .....	36
Receiver Audio Preamp .....	37
Receiver Audio Preamp Tests.....	38
Receiver Front End and T/R Switch .....	38
Receiver Front End and T/R Tests.....	41
Transmitter VXO .....	42
Transmitter VXO Tests.....	44
Transmitter Buffer Circuit .....	45
Transmitter Buffer and T/R Switch Tests.....	47
Transmitter PA Circuit.....	48
Transmitter PA Tests .....	51
Board Connections.....	52
System Connection Block Diagram.....	56
Mounting into a case.....	57
A Note on PC Sound Cards .....	58
Pre-Loading of SDR software on the PC.....	58
Notes on loading PowerSDR .....	60
SDR Receiver Resources .....	62
Receiver Tune Up.....	63
Operating the Firefly SDR.....	64
Firefly SDR Customizations and Optimizations.....	65
Appendix A. Parts List.....	68
Appendix B. Keyer Instructions .....	70

## List of Figures

Figure 1. Working over an oversized cookie sheet is highly recommended to catch stray surface mounted parts.....	8
Figure 2. A temperature controlled soldering helps a lot. 750 degrees is recommended form non-lead tinned boards.....	8
Figure 3. A very pointed soldering iron tip is a very big help for small surface mounted components....	9
Figure 4. Headband Magnifiers. “Mag-eyes” from JoAnn Fabrics.....	9
Figure 5. Package as it arrives from Hendricks QRP Kits.....	10
Figure 6. Internal contents of the box.....	11
Figure 7. Contents of the main bag spread out. Note #26 thicker wire and # 32 thinner wire.....	11
Figure 8. Color coded surface mounted parts. Long clear strip is the 0.1 uf caps (no color code). ....	12
Figure 9. Color coded packages.....	12
Figure 10. List of new color codes for 20m only parts.....	13
Figure 11. Inventory of common, non-band specific parts included in the kit.....	13
Figure 12. Band specific parts for 30 and 20m.....	14
Figure 13. Surface mounted resistors used in this kit and their markings.....	14
Figure 14. Close up of part of the surface mounted resistors.....	15
Figure 15. The remainder of the surface mount resistors.....	16
Figure 16. Top side view of the Firefly SDR PC board.....	19
Figure 17. Bottom side view of the Firefly SDR circuit board.....	20
Figure 18. 5v, 6v Regulator and 12v input areas highlighted, top side.....	21
Figure 19. Bottom side parts location of 6v regulated.....	21
Figure 20. Top side view of 5v regulator, protection diode, and 9v temporary connection. Note D7 diode polarization!.....	22
Figure 21. Lead forming of the LM78M05 5v regulator before installation.....	22
Figure 22. 6v regulator with C67 shorted and C13 installed. Note T3 flat side orientation and C13 stripe orientation.....	22
Figure 23. Bottom side of the 6v regulator w/ C11 and C12 installed.....	22
Figure 24. Ground point and 5v/6v regulator output test points.....	23
Figure 25. Top side parts location of the CW side tone monitor amplifier.....	24
Figure 26. Bottom side parts location of the CW side tone monitor amplifier.....	25
Figure 27. Top side IC2, C73, C1, volume trim pot R8 and R32. Note IC2 polarity and black stripes on C1 and C73.....	25
Figure 28. Bottom side installation of R5, R6, and C5.....	26
Figure 29. Top side location keyer circuitry.....	27
Figure 30. Bottom side location of keyer chip components C59, C60, and C91.....	27
Figure 31. Top side keyer parts. Note the orientation of IC8. IC8 Notch is at the top end.....	28
Figure 32. Bottom side components of the keyer circuit.....	28
Figure 33. Temporary connection of a headphone jack to test the CW side tone monitor speaker output.....	29
Figure 34. Top side location of the receiver crystal oscillator circuitry.....	30
Figure 35. Bottom side location of the receiver crystal oscillator circuitry.....	30
Figure 36. Top side receiver LO parts mounted.....	31
Figure 37. Bottom side receiver LO parts mounted.....	31
Figure 38. Top side location of the receiver crystal oscillator circuitry.....	32

Figure 39. Bottom side location of the receiver crystal oscillator circuitry.....	33
Figure 40. Top side receiver LO parts mounted .....	33
Figure 41. Bottom side receiver LO parts mounted.....	33
Figure 42. Top side location of the detector circuit .....	34
Figure 43. Bottom side location of the detector circuit .....	35
Figure 44. Top side Detector, R2, R4, C86, and IC9.....	35
Figure 45. Close up of bottom side detector circuit.....	35
Figure 46. Top placement of receiver audio preamp stage .....	37
Figure 47. Close up of the parts in the audio preamp stage (top side only).....	37
Figure 48. Top placement of receiver front end and T/R switch .....	38
Figure 49. Bottom placement of receiver front end and T/R switch .....	39
Figure 50. Close up of bottom T/R parts. R69, C69, C70 and C81 .....	39
Figure 51. Close up of top side receiver front end and T/R switch .....	39
Figure 52. Close up of input receiver filter inductor L9. 30m values shown. For other bands see text. 40	
Figure 53. Top side location of the transmitter VXO .....	42
Figure 54. Bottom side location of the transmitter VXO.....	42
Figure 55. Close up of top side installed transmitter VXO parts.....	43
Figure 56. Close up of the bottom side installed transmitter VXO parts.....	43
Figure 57. Top side location of the TX Buffer circuit .....	45
Figure 58. Bottom side location of the TX buffer circuit. ....	45
Figure 59. Top side TX buffer parts installed. IC7, D3, R43, C41.....	46
Figure 60. Bottom side TX buffer with parts installed .....	46
Figure 61. Top side test points for the T/R switch in the receiver front end .....	47
Figure 62. Location of keyer paddle inputs to test the T/R switch .....	48
Figure 63. Top side view of the PA circuit.....	48
Figure 64. Bottom side view of the PA circuit .....	49
Figure 65. Top side parts view of the PA circuit. C50 (left top end cap) not used on the 30m version. 49	
Figure 66. Bottom side part view of PA circuit. C53 not used in the 30m version .....	49
Figure 67. Close up of Zener diode D1 with band orientation .....	50
Figure 68. Location of 20m modification, C14. Bottom side of TX low pass filter L6. ....	51
Figure 69. Antenna coax connection to transceiver. Upper connection is ground, lower is antenna. ....	51
Figure 70. Connections for J1, I/Q (R/L) audio output to the PC sound card input .....	52
Figure 71. Connections of the I/Q audio output to its audio jack .....	52
Figure 72. Connections for X1 and R98, CW side tone monitor speaker and 100K CW speed pot. ....	53
Figure 73. Connections to CW mon speaker jack, CW speed pot. Remove temporary resistor across R98.....	53
Figure 74. Connections for keyer paddle inputs (X2) and for keyer programming push button switch (S2).....	54
Figure 75. Visualization of paddle jack and keyer programming switch connections .....	54
Figure 76. Connections for TX spot switch (S1) and TX VXO 10K tuning pot (R99).....	54
Figure 77. Visualization of TX tuning pot and VXO spot switch connections. Switch shown "Spot On". .....	55
Figure 78. Connections for 12v to the board .....	55
Figure 79. Antenna Connections.....	55
Figure 80. External connections from a case view .....	56
Figure 81. Diagram of the major external interfaces of the Firefly SDR, less front panel controls.....	56

Figure 82. Mount all four corners of the main board using the mounting hardware as shown. ....	57
Figure 83. Homebrew case fashioned out of double sided PC board, 5" x 3.5" x 1.375".....	57
Figure 84. Select the setup tab to get to this window. Select SoftRock, and set the center frequency...	60
Figure 85. Sheet used to calibrate the signal strength readings in Power SDR.....	60
Figure 86. DSP/Image Reject tab used to null opposite sideband signal.....	61
Figure 87. Generic settings – NB on, 500 Hz filter, CWU, proper band selected (30m here) .....	61
Figure 88. Adjustment points for tuning up the receiver.....	63
Figure 89. Pi Attenuator values – 3 db to 30 db .....	66
Figure 90. If the input attenuator is increased, Rx can be placed across the above 2 points, keeping R1 as is.....	66
Figure 91. Tx VXO tuning linearity improved by using an external 4.7K resistor .....	67
Figure 92. Common, non-band specific part .....	69
Figure 93. Band specific parts .....	69
Figure 94. A Function Table of the Keypress Combinations .....	70
Figure 95. Mem + dit menu (PAR mem to advance to the next menu item).....	71
Figure 96. Mem + dah menu (PAR mem to exit) .....	72
Figure 97. Mem switch menu (PAR mem to advance to the next menu item).....	73
Figure 98. Mem + both menu (PAR mem to exit).....	73

## Specifications

As measured from current prototypes, some variance in performance is expected from unit to unit.

### *Receiver*

**Tuning range:** **30m:**10.090 to 10.138 MHz; **20m:** 14.034 to 14.082 MHz in software using free software packages such as PowerSDR and Rocky

**Curent Drain:** Approximately 37 ma @ 12v.

**Supply voltage range:** 9 to 13.8v

**Receiver bandwidth:** Wideband SDR receiver ~ 3 db down at +/- 24 KHz. Audio selectivity via PC software.

**MDS receiver sensitivity:** Dependent on the PC sound card used. 30m measured: **-127/-128 dbm** in 500 Hz using a Presonus Firebox and PowerSDR software.

**Third order distortion dynamic range (IP3DR):** **93 db**

**Blocking Dynamic Range (BDR):** **~100 db**

### *Transmitter*

**Power Output - 30m:** ~2.5w at 12v (3.5w with addition of 47 pf at C14); **20m:** ~3.5w at 12v

**TX tuning range - 30m:** 10.102 to 10.113 KHz, 11 KHz range; **20m:** 14.042 to 14.058 KHz, 16 KHz range. *Low end TX tuning range dependant on the exact crystals used.*

## Note to the Reader

*In the interest of “time to market”, I am shamelessly lifting the following few sections kit building sections from the NC2030 manual. Please ignore the references to the NC2030 – Dan, N7VE*

## Building the Kit

### *Things you will need*

#### **Jacks, pots, switches, and push buttons, and a case specifically:**

- **Three 1/8” stereo jacks** (I/Q audio output, Monitor speaker output, Paddle inputs)
  - **One small push button switch**, normally open (programming button for the keyer)
  - **One sub-miniature SPST switch** (used for spotting the TX VXO on frequency)
  - **One 100K linear panel mounted pot** (keyer speed pot)
  - **One 10K linear panel mounted pot** (used to tune the TX VXO frequency)
  - **One antenna jack**
  - **One rear 12v power connector**
  - **One case.** Dimensions should be at least 5” in depth, 3.5” wide and 1 3/8” tall. The case should be metal to provide shielding on the TX VXO from the radiated antenna signal.
- 
- One 1/4w resistor for testing, 10K to 100K
  - 9v battery clip (for temporary power connection for testing)
  - Fresh 9v battery (for a low current power source for testing)
  - Clear nail polish (“Sally Hansen Diamond Strength” highly recommended for hardness. Source: Ulta)
  - Tweezers
  - Solder sucker (highly recommended) or solder wick
  - Temperature control soldering iron with a fine tip
  - 8 pin socket for the keyer chip (optional)
  - Magnifying headpiece and/or magnifying glass. 3.5 power reading glasses may work also. Try them on and check for focus at a 6 to 8” operating distance.
  - Cookie sheet (highly recommended for building on top of in order to catch stray parts)

**An important note:** SDR radios have traditionally had a number of complaints concerning performance problems related to intermittent connections in the low level audio jacks. The use of good connectors and gold plated audio cables plugs have proved to be helpful in obtaining consistent day to day receiver performance. Cheap audio jacks and cheap audio cables provide for a good low cost starting point, but can be problematic in the long run.

Good shielded audio cables between the receiver low level I/Q audio output and the input to the computer sound card is very helpful in keeping out spurious signals. Given a choice, make this cable as short as possible.



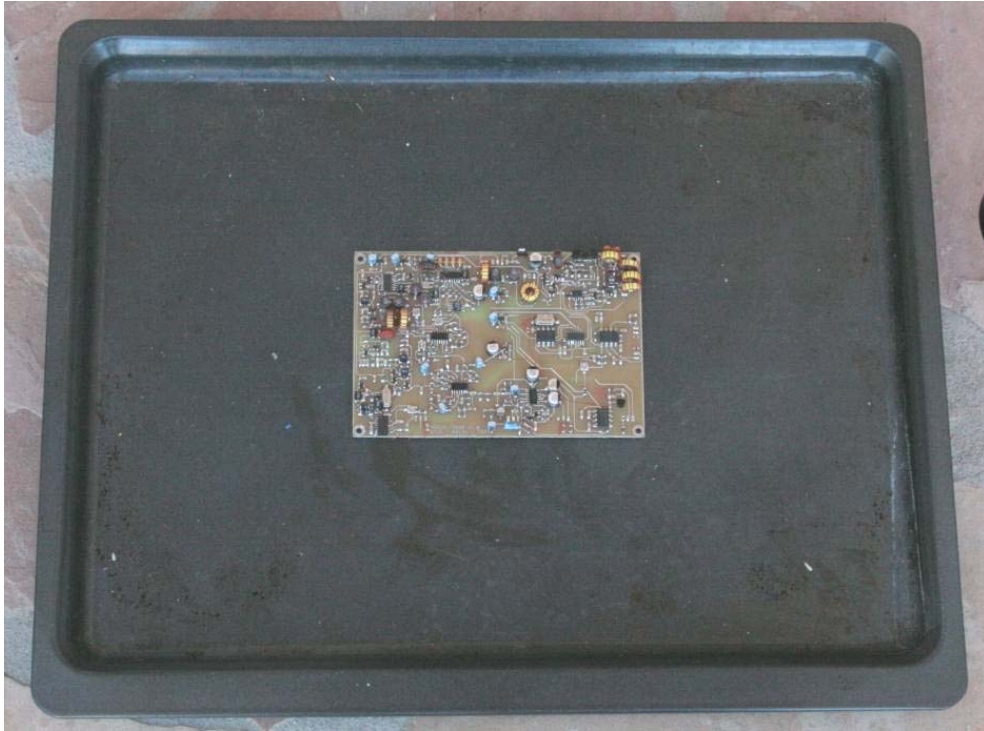

Figure 1. Working over an oversized cookie sheet is highly recommended to catch stray surface mounted parts



Figure 2. A temperature controlled soldering helps a lot. 750 degrees is recommended form non-lead tinned boards





**Figure 3. A very pointed soldering iron tip is a very big help for small surface mounted components**



**Figure 4. Headband Magnifiers. "Mag-eyes" from JoAnn Fabrics**

As far as magnification, I think that common reading glasses may be just as good. Try 3.5 or 3.25 magnification glasses. Try them on and check the focus distance. Ideal is a focus distance of about 8 inches.

I use the above Mag-eyes with my normal 1.5x reading glasses. I can gang both the reading glasses and the Mag-eyes together to get a really good, close up look at the parts. However, it does drive my eyes a bits nuts switching from no glasses to glasses, to Mag-eyes, to glasses plus Mag-eyes.

### *Parts List*



Figure 5. Package as it arrives from Hendricks QRP Kits



Figure 6. Internal contents of the box

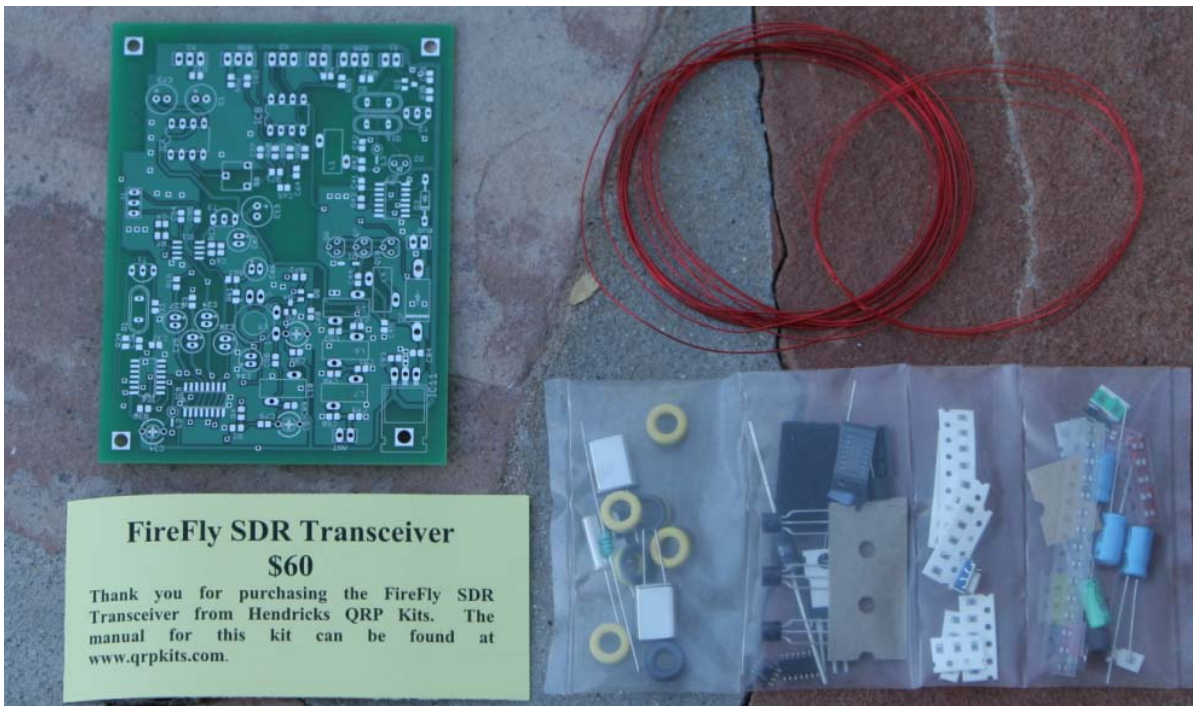

Figure 7. Contents of the main bag spread out. Note #26 thicker wire and # 32 thinner wire.





Figure 8. Color coded surface mounted parts. Long clear strip is the 0.1 uf caps (no color code).

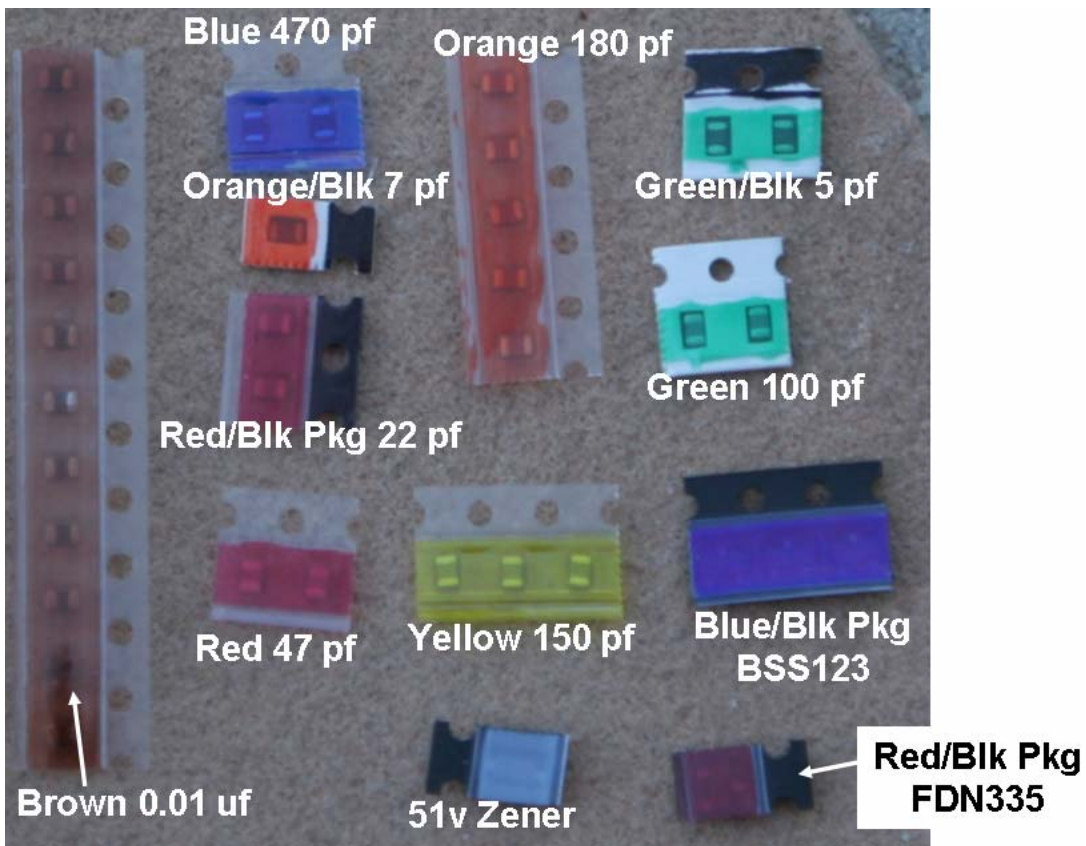

Figure 9. Color coded packages

*Not all parts in the kit have markings on them.* This includes all the surface mounted caps and some of the surface mounted transistors and diodes. The two figures above shows the color codes that have been placed on these packages in order to aid in the parts identification process.

A few new color codes have been added for the new 20m parts. These are listed below:

- 27 pf red/green
- 33 pf red/blue
- 68 pf blue/black
- 120 pf yellow/black
- 330 pf red/yellow

Figure 10. List of new color codes for 20m only parts

Part	Value	Package
11	0.01 uf	C0805
26	0.1 uf	C0805
2	150 pf	C0805
1	22 pf	C0805
1	47 pf	C0805
2	5 pf	C0805
1	22 uf	Electrolytic cap
3	100 uf	Electrolytic cap
3	50 pf	trimer cap
1	49v Zener	SOD123
1	MV209	SOT54H
1	1N4148	DO35-10
1	SB320	DO201-15
1	LT6231	SO08
1	LM386-N4	LM386
1	78L06	78LXX
1	74AHC04D	SO14
1	74AC00D	SO14
1	Norcal Keyer	DIL8
1	74CBT3253D	SO16
1	7805T	TO220H

Part	Value	Package
1	FT37-43	T37_INDUCTOR
6	T37-6	T37_INDUCTOR
3	BSS123	SOT23
1	FDN335	SOT23
3	BS170	SOT54E
2	2N4401	TO92-CBE
1	5K trim pot	3318_TRIMMER
3	18	M0805
2	100	M0805
2	300	M0805
5	100k	M0805
7	1k	M0805
9	3.3k	M0805
2	33k	M0805
1	47k	M0805
5	75k	M0805
2	8.2k	M0805

Figure 11. Inventory of common, non-band specific parts included in the kit

Part	30m	Part	20m
1	7.5 pf	1	5 pf
1	22 pf	1	27 pf
1	47 pf	1	33 pf
2	100 pf	1	47 pf
1	150 pf	2	68 pf
5	180 pf	1	100 pf
2	470 pf	1	120 pf
		4	150 pf
1	10 uH	2	330 pf
3	10.116 MHz	1	4.7 uH
		3	14.060 MHz

47 pf disc cap

Figure 12. Band specific parts for 30 and 20m

Resistor Values	Resistor Markings
18	180 – <i>Note: this is not a 180 ohm resistor!</i>
100	1000 – This is a 1% resistor (4 digits) – <i>This is not a 1K (1000 ohm) resistor!</i>
300	301
1k	102 – <i>Don't confuse with the 1% 100 ohm (marked 100) above!</i>
3.3k	332
8.2k	822
33k	3302 – This is a 1% resistor (4 digits)
47k	473
75k	753
100k	104

Figure 13. Surface mounted resistors used in this kit and their markings



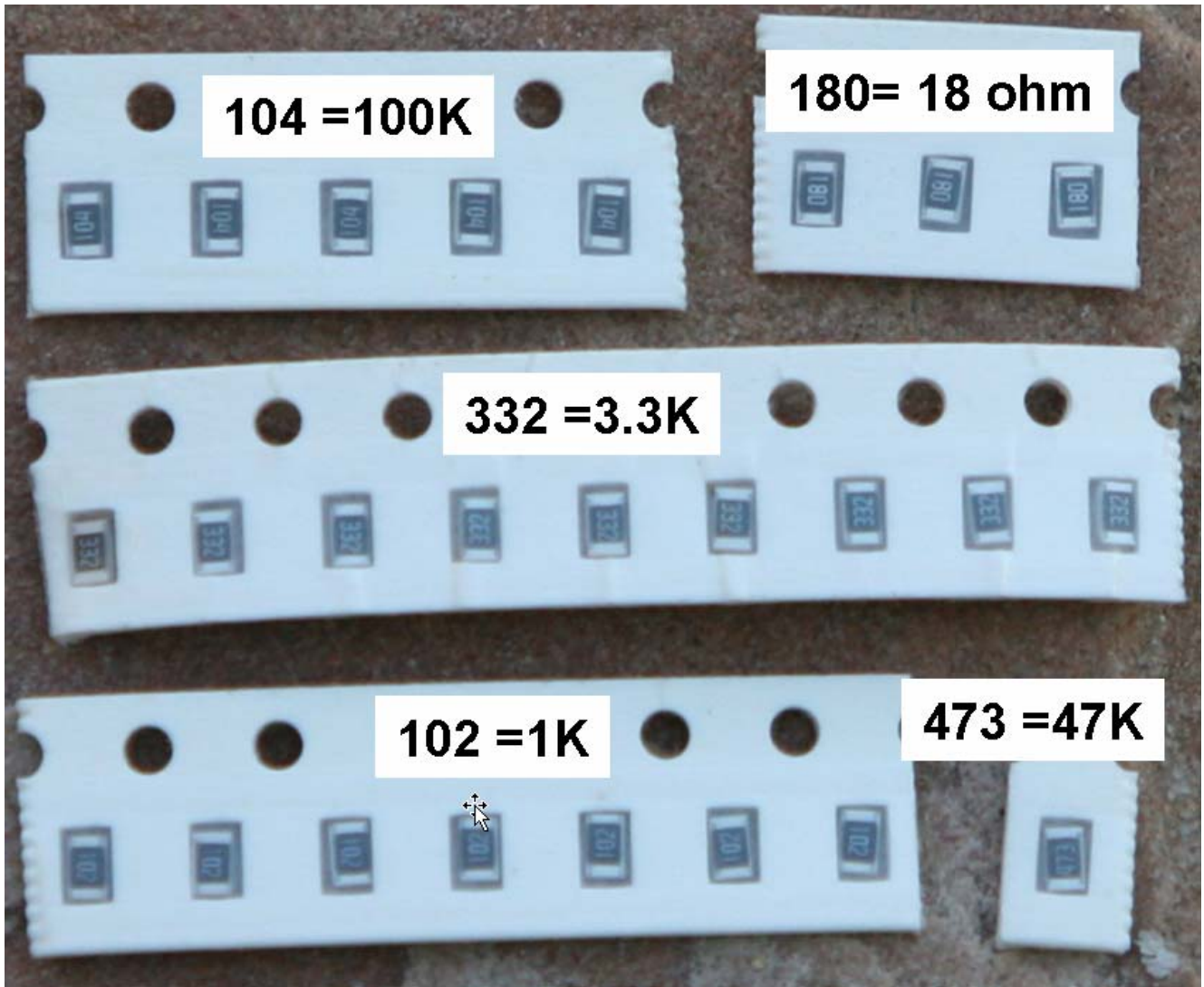

Figure 14. Close up of part of the surface mounted resistors

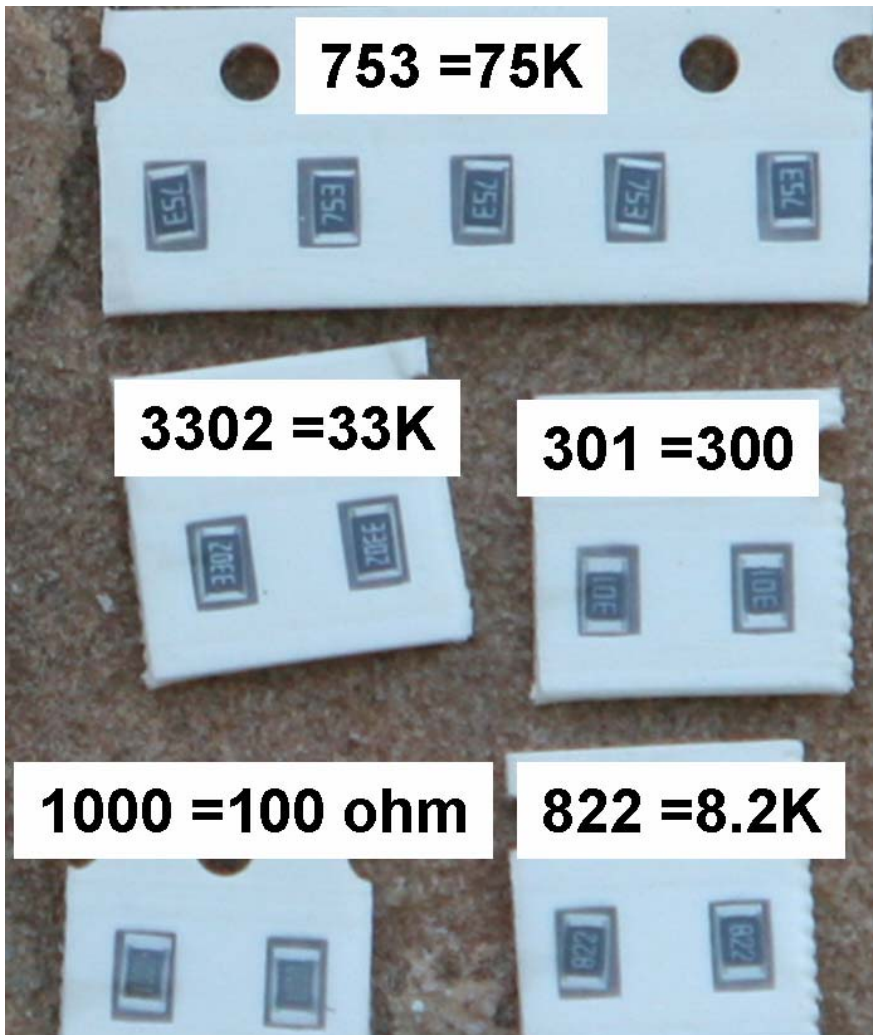

Figure 15. The remainder of the surface mount resistors.

***The markings of the surface mounted resistor used in this kit can be confusing. Take special note that “1000” is 100 ohm, 1% resistor (not 1K!) and “180” is an 18 ohm resistor. Also “3302” is a 1% 33K resistor. If in doubt, measure it with an ohm meter!***

*Note: There are a few “one of” surface mounted parts in the color coded parts figure above. It may be good at this time to mount the following single parts just to keep from loosing them:*

- D1 (51v Zener – See PA section),*
- Q5 (FDN335 – See TX Buffer section),*
- C90 (7 pf – see Receiver Front End section)*

## ***Tools and Construction Hints***

There are many great articles on the web that describe techniques on building surface mount projects. Alas, I am guilty of often using a bit too much solder. Rather than right my own version of this, let me repeat some of these links:

[www.geocities.com/vk3em/smtguide/websmt.html](http://www.geocities.com/vk3em/smtguide/websmt.html)

[www.seed-solutions.com/gregordy/Amateur%20Radio/Experimentation/N2PKVNA/SMT.htm](http://www.seed-solutions.com/gregordy/Amateur%20Radio/Experimentation/N2PKVNA/SMT.htm)

[www.piclist.com/techref/smds.htm](http://www.piclist.com/techref/smds.htm)

In building this transceiver myself and creating the manual, I have had some problems. These fall into several different categories:

- 1) IC pins not truly soldered
- 2) ICs mounted backwards
- 3) Resistors and capacitors not soldered to the right set of pads
- 4) Not all parts were installed
- 5) Bad resistor (part was open)

In helping others, I also had several cases where folks soldered one end of a resistor or capacitor, but not the other end.

Between testing prototypes and building the final transceiver, I have built five of the NC2030s and three of the Firefly SDRs. Please learn from my mistakes. Each time an IC is mounted, check the mounting polarity twice before soldering it in. I suggest checking the IC polarity, soldering down one corner pin, and then checking it one more time before finishing the job. I think the old saying is “measure twice, cut once”.

I have several times mounted caps and resistors to the wrong set of pads. This problem can be corrected by mounting the resistors first, double checking the resistor placement against the pictures, and mounting the capacitors after all the resistors are mounted. The assembly instructions have been modified to reflect this order.

I have once been bit by not mounting all the parts. Double check the pictures against your kit to make sure things end up in the right place.

You may find that the components in the pictures may be slightly different from what is in your kit. This may be partially due to the fact that the pictures are of the 20m version.

Lastly, I have had IC pins that look soldered, but are not. This happens when the top of the lead of the part gets soldered, but the solder does not extend to the pad. This happened a few times until I figured out a trick to make sure that all pins were properly soldered.

After soldering pins on both sides to firmly anchor the IC, I run a bead of solder down both sides of the IC. All pins are now shorted to each other. Next I heat sections of that bead with the soldering iron and use the solder sucker to suck away the excess. You have to be fast removing the iron and getting the sucker in place before the solder has a chance to cool, but this seems to work very well. When using the approach, carefully inspect the pins when finished to make sure there is no solder left between the pins. It is not uncommon for a very light solder film to be left which can be cleaned up with either a knife or a very small screw driver blade or a light touch of the soldering iron.

This manual has been set up to build a section, and then test it. The tests are normally quite simple. This should find most problems as we go from stage to stage rather than getting to the end and not knowing where to start.

I found building the transceiver over a large cookie sheet eliminated the problem of dropping parts and loosing them. However, when doing the applied voltage tests, you should place a few sheets of clean paper under the boards to keep them from shorting out against the cookie sheet.

I find that this radio can be built in about six hours. One good Saturday should do it.



*Bare PC Board Pictures*

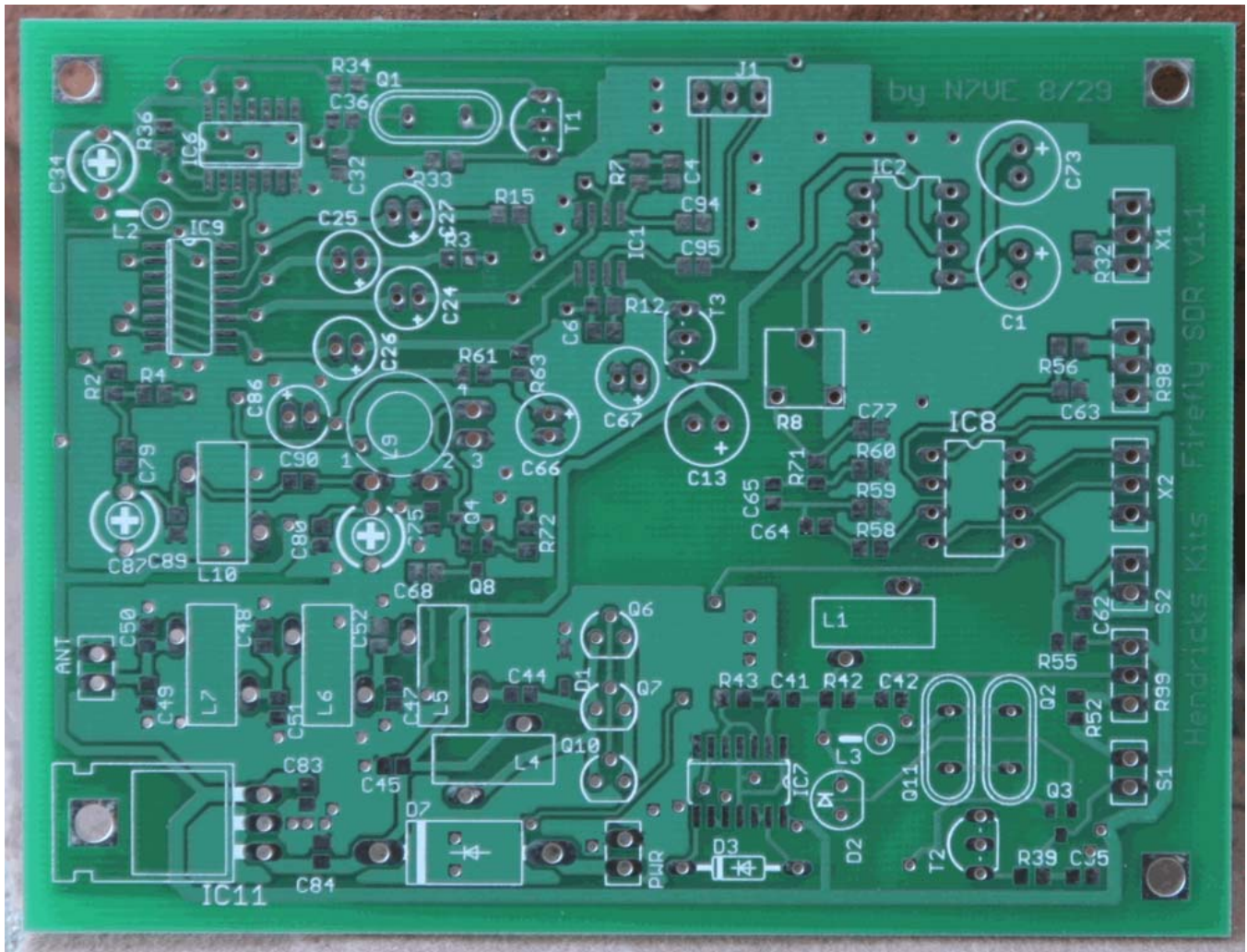

Figure 16. Top side view of the Firefly SDR PC board

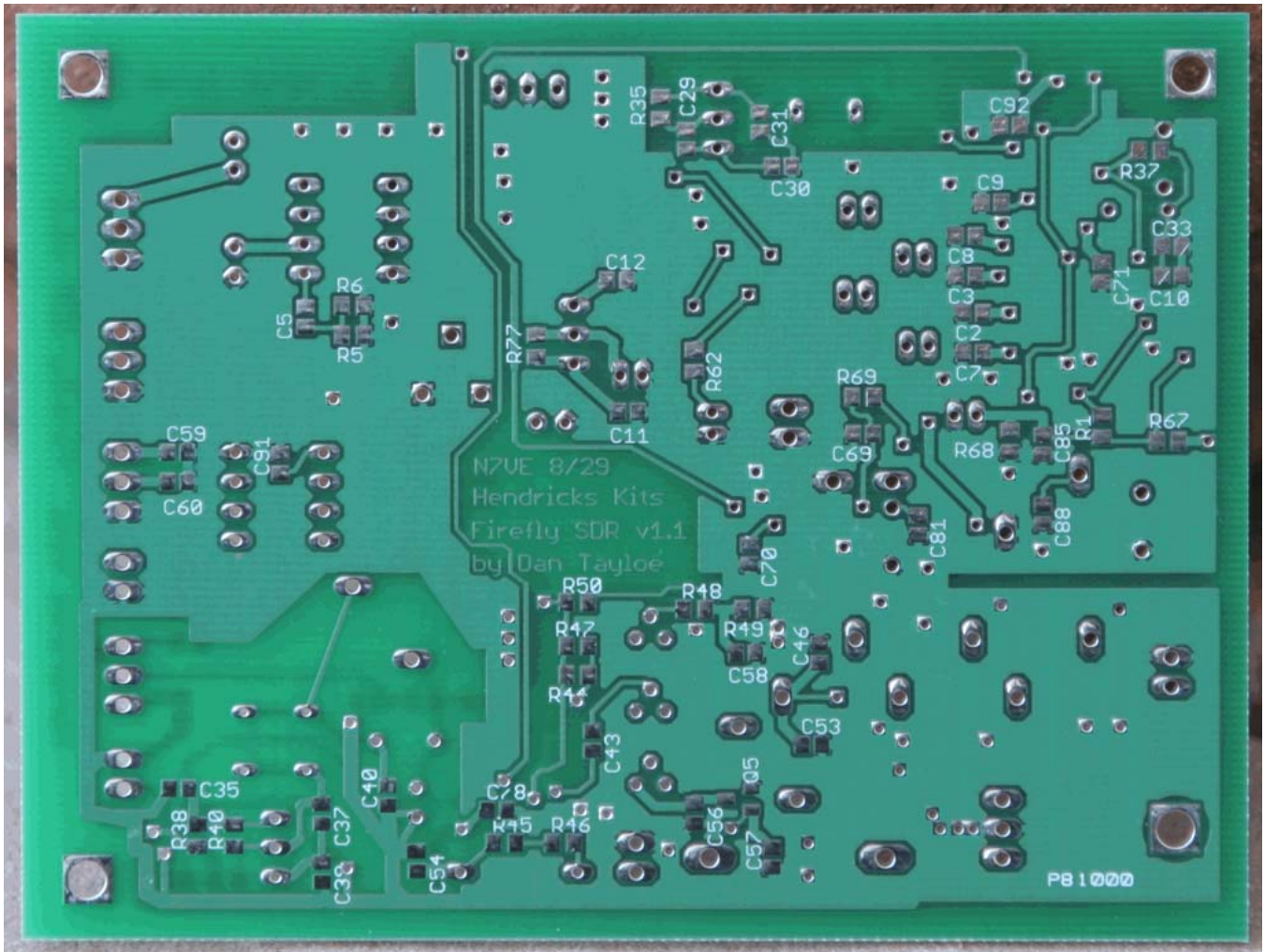

Figure 17. Bottom side view of the Firefly SDR circuit board.



## Power Connections and 5 and 6v Regulators

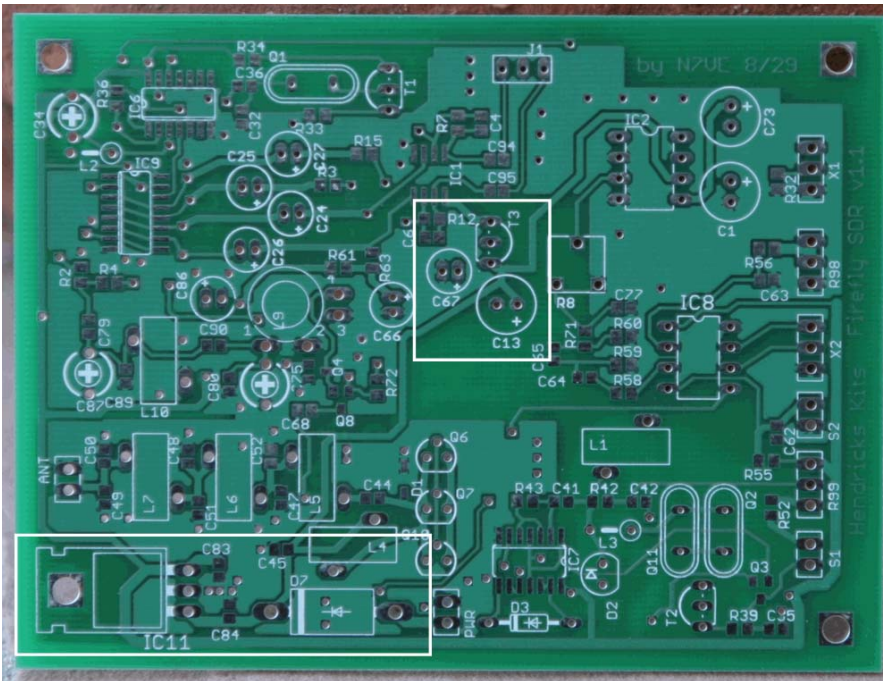

Figure 18. 5v, 6v Regulator and 12v input areas highlighted, top side

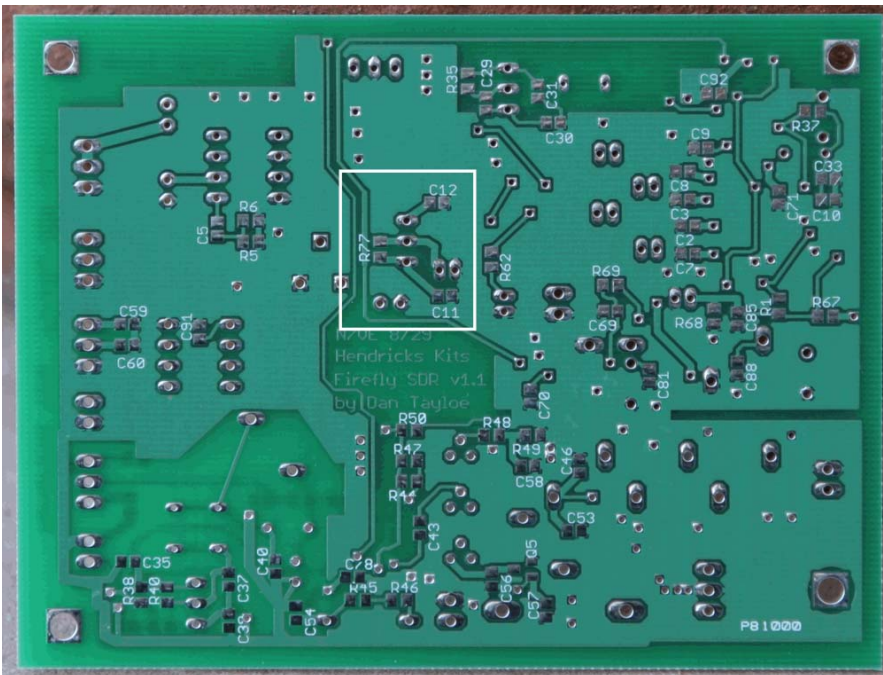

Figure 19. Bottom side parts location of 6v regulated

I suggest using a 9v battery clip to temporarily supply power to the board. This is a low current, temporary power connection that protects the board in case of a problem. ***The 9v battery clip is not supplied.***

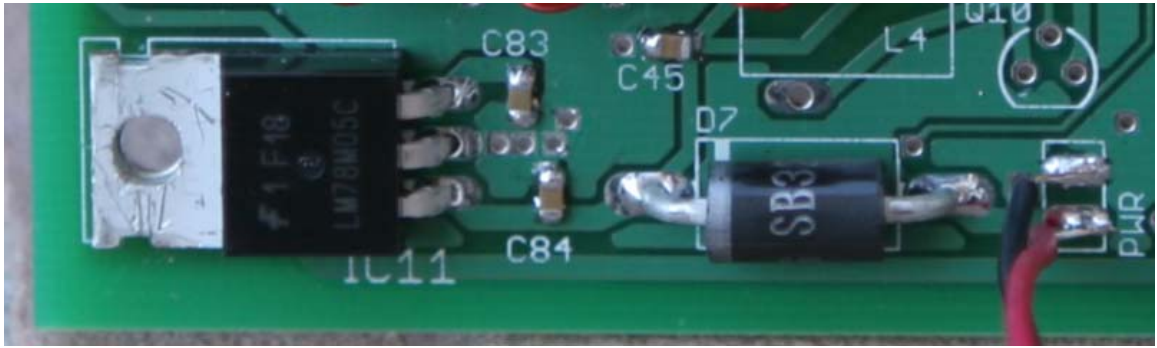

Figure 20. Top side view of 5v regulator, protection diode, and 9v temporary connection. Note D7 diode polarization!

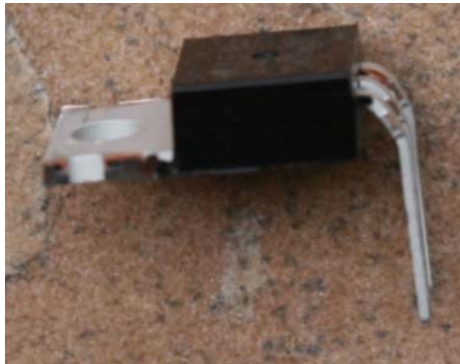

Figure 21. Lead forming of the LM78M05 5v regulator before installation

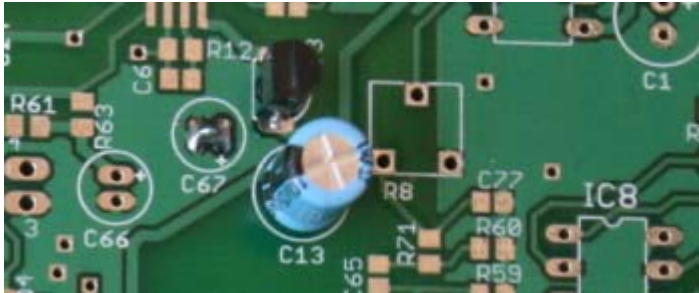

Figure 22. 6v regulator with C67 shorted and C13 installed. Note T3 flat side orientation and C13 stripe orientation.



Figure 23. Bottom side of the 6v regulator w/ C11 and C12 installed

Install □ IC11 (LM78M05). **Make sure hole of the regulator matches up with the mounting hole on the board!**

Install □ T3 (LM78L06), □ D7 SB320. **Double check the polarity against the above picture! Check the diode band polarity, and match the flat side of T3 against the flat side outline on the board.**

Install 0.1 uf caps (no color markings). Top side: □ C83, □ C84; Bottom side: □ C11, and □ C12

Install □ C13, 100uF polarized capacitor. This is a polarized capacitor, **so make sure it is installed with the correct polarization**. The black stripe on the top of the cap is the negative side of the capacitor. The non-striped side matches with the “+” symbol marked on the board. **Double check against the orientation on the board.**

□ Short C67 (not used).

### 5 and 6v Regulator Tests

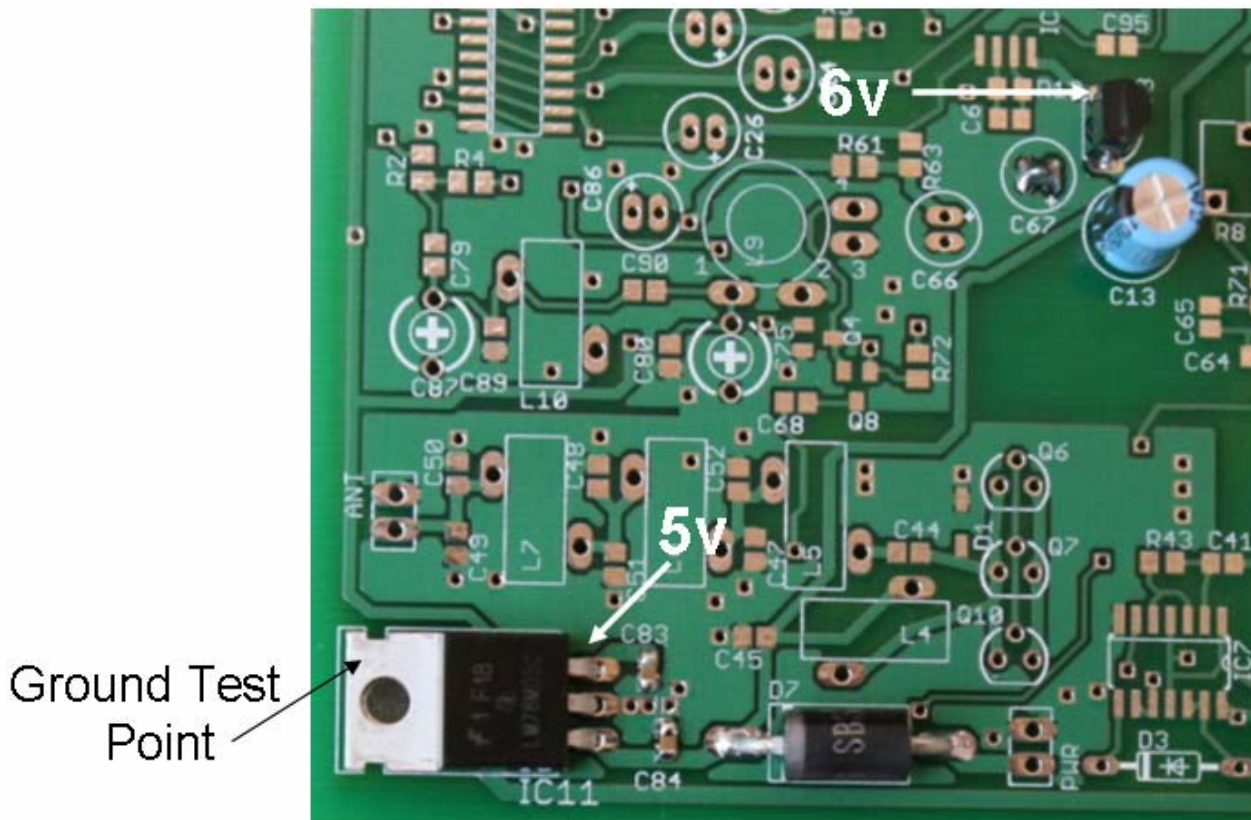

Figure 24. Ground point and 5v/6v regulator output test points



The drain on the 9v battery should be **about 9 ma**. The current drain can be tested by connecting the 9v battery by one terminal only, then connecting a voltmeter between the remaining battery terminal and remaining 9v battery clip terminal.

The input voltage to the board is diode protected. Thus you will not damage the board by hooking the battery up backwards.

The tab of the 5v regulator is one of the only good ground connection points on the entire board. All voltage measurements from this point on will this regulator tap as the ground point.

Measure and verify the 5v and 6v outputs as shown above. However, if the current drain is right, it is highly likely that all is well.

***At this time, remove the 9v battery connection.***

### ***Sidetone monitor Amplifier***

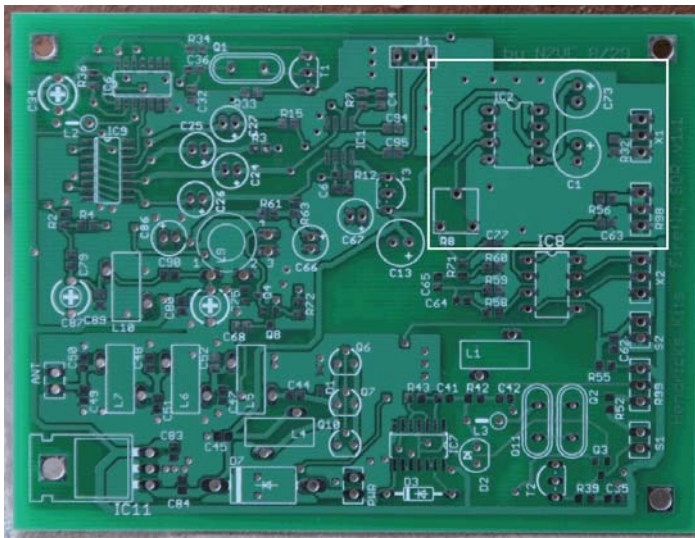

Figure 25. Top side parts location of the CW side tone monitor amplifier

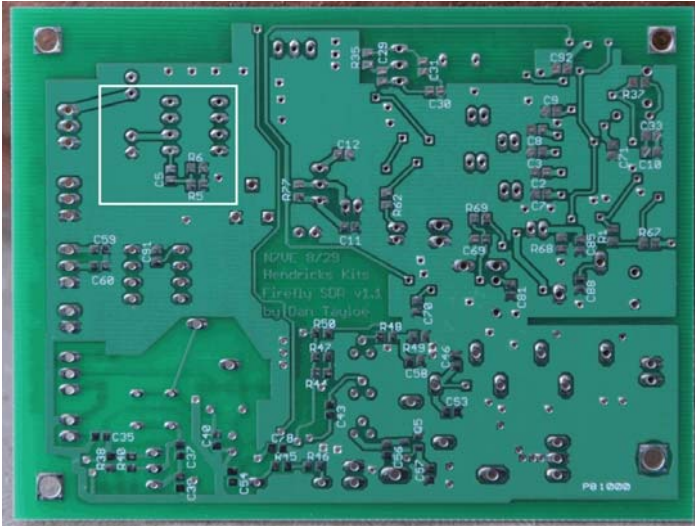

Figure 26. Bottom side parts location of the CW side tone monitor amplifier



Figure 27. Top side IC2, C73, C1, volume trim pot R8 and R32. Note IC2 polarity and black stripes on C1 and C73.

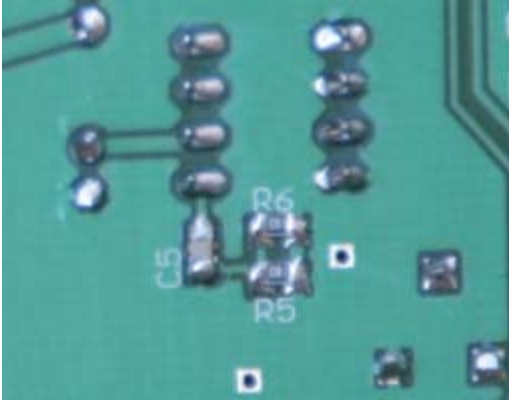

Figure 28. Bottom side installation of R5, R6, and C5.

Install the following parts in the following order:

- Install  IC2 (LM386-4). ***Double check the orientation of the IC before soldering it in. Solder one pin, double check the orientation with the picture above, and then solder the rest of the pins.***
- Install  C1,  C73 100 uf. ***Double check the polarity of the black stripe against the photos above.***
- Install  R8 (5K trim resistor),  R32 (1K marked 102).
- Install  R5,  R6 (18 ohm – marked 180) and  C5 (0.1 uf – no color code)) on the bottom side.

### ***CW Side Tone Monitor Amplifier Test***

This will be tested more completely after the next section. The easiest test is to check the board current draw when connected to the 9v battery. At this point the current drain is in the 13.5 to 14.5 ma range.



## Keyer Circuit

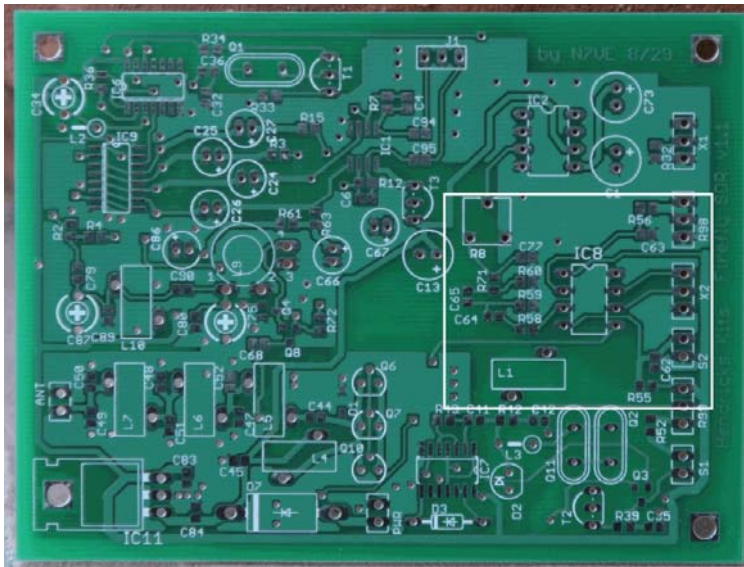

Figure 29. Top side location keyer circuitry

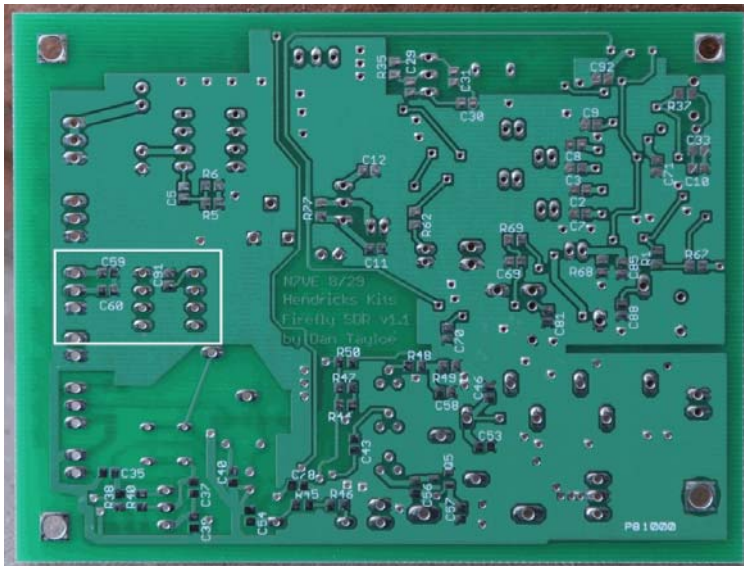

Figure 30. Bottom side location of keyer chip components C59, C60, and C91



Figure 31. Top side keyer parts. Note the orientation of IC8. IC8 Notch is at the top end.



Figure 32. Bottom side components of the keyer circuit

Install □ IC8 (12F629). *Note the IC8 notch orientation in the above picture before soldering! Solder one pin, double check the orientation with the picture above, and then solder the rest of the pins.*

Install 0.01 uf capacitors (brown color code): **Bottom side** □ C59 & □ C60, **top side** □ C62, □ C63.

Install 0.1 uf capacitors (no color code): **Bottom side** □ C91, **top side** □ C64, □ C65, □ C77

Install 3.3K resistors: **Top side** □ R59, □ R60, and □ R71 (marked 332)

Install 1K resistors: **Top side** □ R56, □ R58 (marked 102)

Install 8.2K resistors: **Top side** □ R55 (marked 822)

For temporary testing purposes connect a resistor somewhere in the 10K to 100 K range as shown above across the connections for the CW speed pot R98. I used a 47K resistor because that is what I had closest to hand. This will allow the keyer chip to send **“FB”** out of the side tone speaker monitor output when the board is powered up.

## ***Keyer and CW Side Tone Monitor Amplifier Test***

Connect the 9v battery. If no monitor side tone external speaker is connected, the board current draw when connected to the 9v battery will start at ~ 15.5 ma, then quickly drop back to 14.5 ma. The 1 ma difference is the keyer chip turning on and sending “FB”. The keyer chip will then turn off when done, reducing the current back down to 14.5 ma.

A further and more complete test is to connect an external speaker (or set of headphones) to the CW side tone monitor output, X1. The picture below shows a headphone output connected temporarily across X1. R8 is the volume control for this CW side tone output, and the output is quite loud. I suggest turning R8 down a bit to the setting shown below as it is otherwise a bit loud.

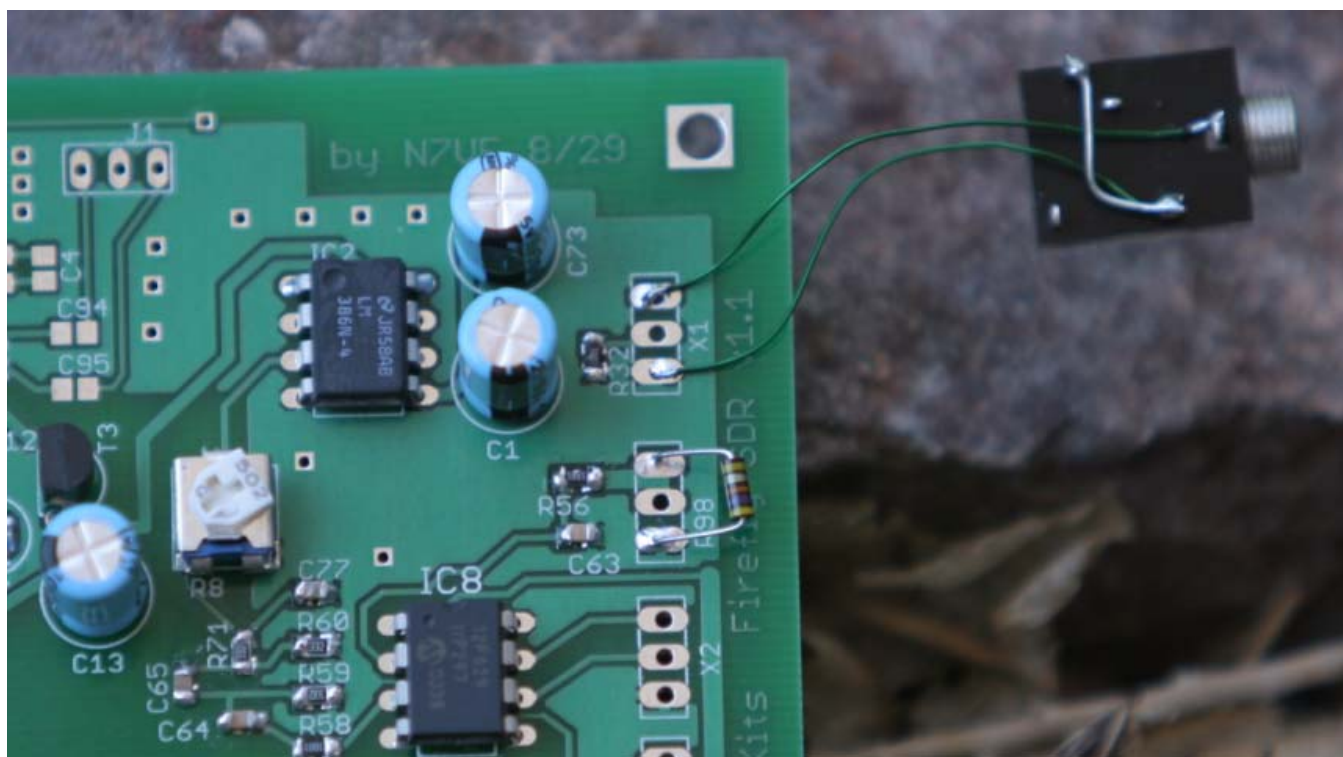

**Figure 33. Temporary connection of a headphone jack to test the CW side tone monitor speaker output**

With a speaker attached, the current drain increased to 24 ma when the board is first powered up and the “FB” is sent. The current then dropped back to 14.5 ma. The high current value will depend on your exact R8 volume setting and the exact impedance of the external speaker.

**Note:** The CW Keyer may not reset properly if the voltage is removed from the rig for only a few seconds. ***If the chip does not reset properly, it will not send the sign on messages on power up.*** If you power off the rig and want to power it back on immediately, you may need to ***press the Keyer push button*** to make sure the processor burns up all stray charge and thus get reset properly before turning the rig back on.

The operating instructions for the keyer are at the end of this manual. The keyer in has several memories, a beacon mode, and a straight key mode where if a straight key is plugged in on power up (or





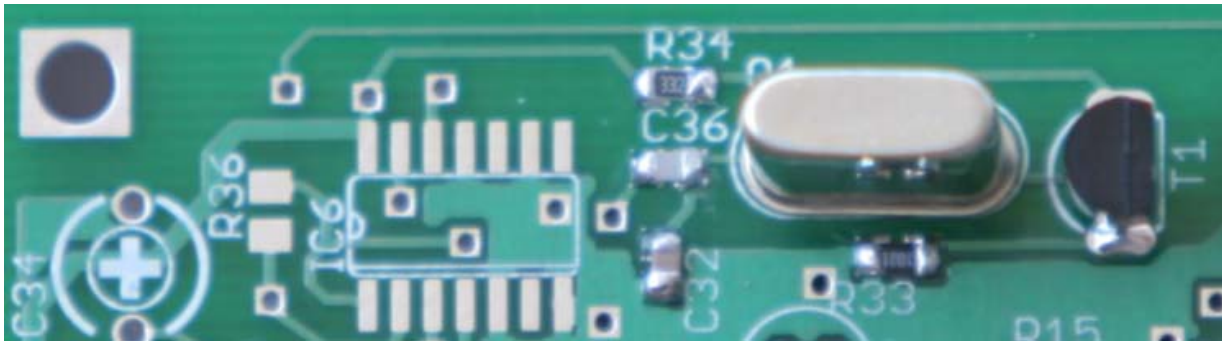

Figure 36. Top side receiver LO parts mounted

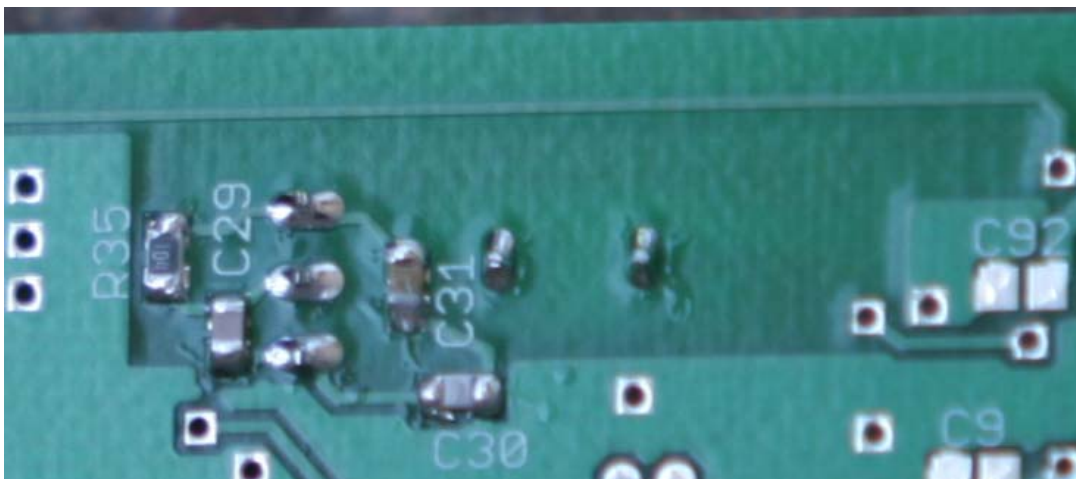

Figure 37. Bottom side receiver LO parts mounted

Install 0.1 uf (no color code) capacitors: **Bottom side** □ C31

Install 100K resistors: **Bottom side** □ R35 (marked 104)

Install capacitors: **Top side** □ C36 (5 pf – Green/Black) & □ C32 (47 pf - Red)

Install 3.3K resistors: **Top side** □ R34 (marked 332)

Install 1K resistors: **Top side** □ R33 (marked 102)

Install 2n4401: **Top side** □ T1. *Make sure the flat side of T1 matches the flat side silk screen marking on the board.*

### 30m specific parts

**Bottom side** □ C30 (180 pf - Orange) & □ C29 (100 pf - Green)

Install □ Q1 10.116 MHz crystal.

## 20m specific parts

Bottom side  C30 (150 pf - Yellow) &  C29 (68 pf – Blue/Black)

Install  Q1 14.060 MHz crystal.

## *Receiver Side Local Oscillator Test*

Connect the 9v battery. After the keyer finishes sending “FB”, the board current draw when connected to the 9v battery will be in the 15.8 to 14.8 ma range, about 1 ma higher than in the previous current test.

A second test is to listen for the oscillator at either 10.114 (30m) or 14.060 MHz (20) on another receiver.

*Disconnect the 9v battery supply.*

## *90 Degree Phasing Section and LO Buffer*

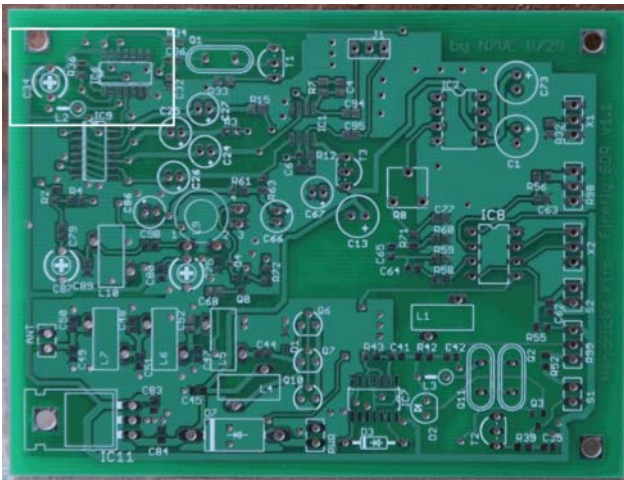

Figure 38. Top side location of the receiver crystal oscillator circuitry



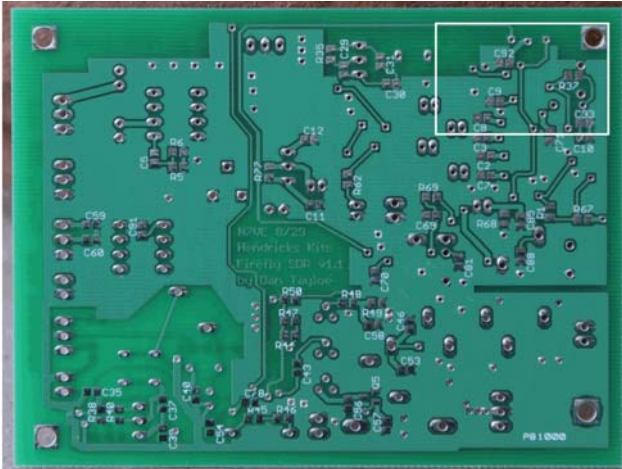

Figure 39. Bottom side location of the receiver crystal oscillator circuitry



Figure 40. Top side receiver LO parts mounted



Figure 41. Bottom side receiver LO parts mounted

Install □ IC6 (74AHC04): **Top side**. *Caution! Install with the polarity as shown above! Solder one pin, double check the orientation with the picture above, and then solder the rest of the pins.*

Install capacitor: **Top side** □ C34, 50 pf trim cap. *Caution! Install flat side down as shown above! These caps must have the right orientation or it will affect tune up (hot end, ground end). See the figures above!*

Install resistor: **Top side** □ R36, 100K (marked 104)  
Install capacitors: **Bottom side** □ C92 (0.1 uf – No color code)  
Install 1K resistor: **Bottom side** □ R37 (marked 102)

### 30m specific parts

**Bottom side** - □ C33 (22 pf – Red/Black)  
**Top side** - □ L2, 10 uH molded choke. *Note the part is installed standing on end.*

### 20m specific parts

**Bottom side** - □ C33 (27 pf – Red/Green)  
**Top side** - □ L2, 4.7 uH molded choke. *Note the part is installed standing on end.*

## *90 Degree Phasing Section and LO Buffer Tests*

Connect the 9v battery. After the keyer finishes sending “FB”, the board current draw when connected to the 9v battery will be in the 22 ma range.

*Disconnect the 9v battery supply.*

## *Detector Circuit*

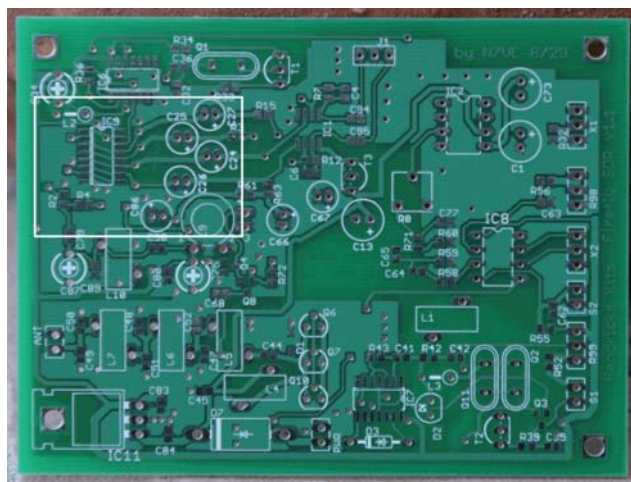

Figure 42. Top side location of the detector circuit

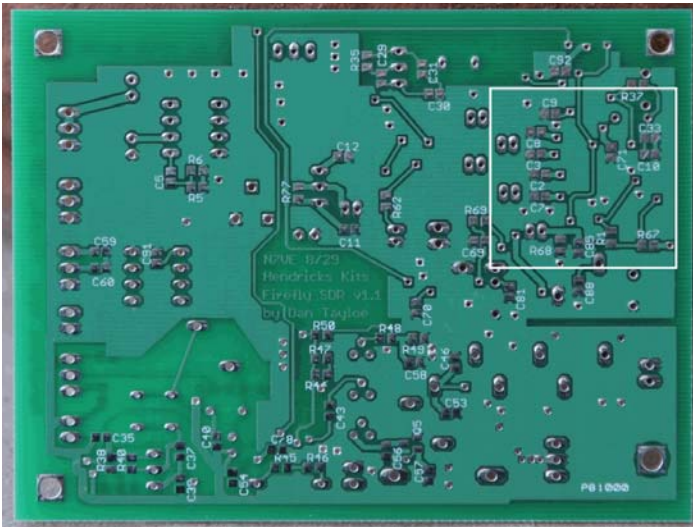

Figure 43. Bottom side location of the detector circuit

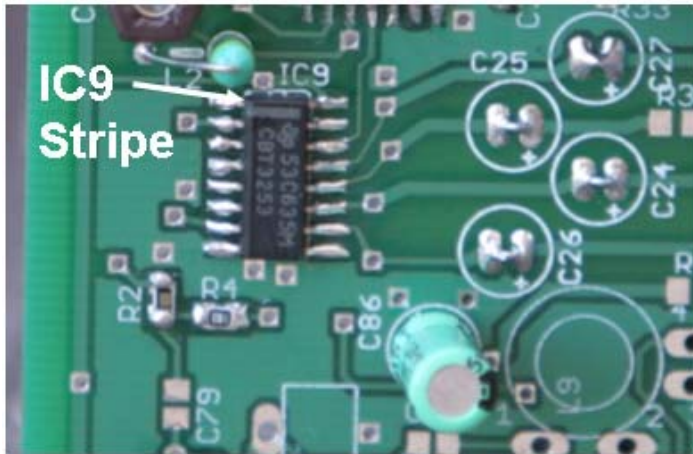

Figure 44. Top side Detector, R2, R4, C86, and IC9

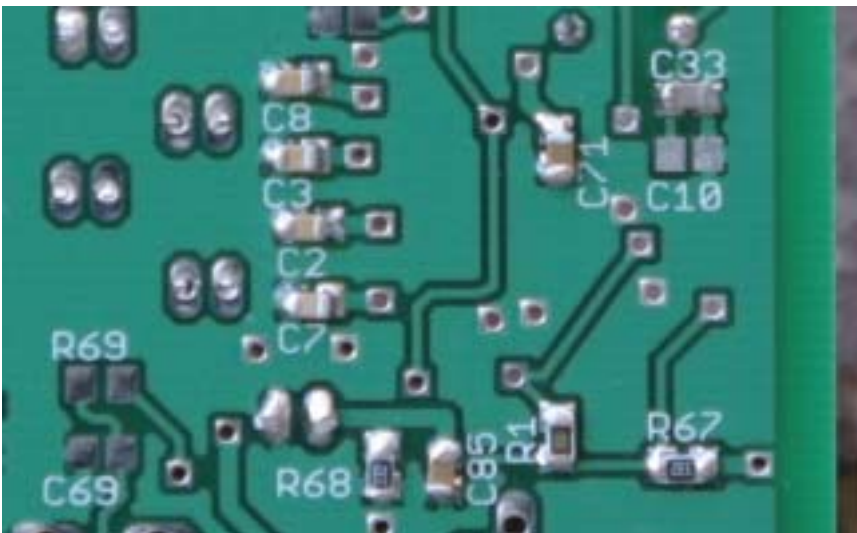

Figure 45. Close up of bottom side detector circuit

Install □ IC9 (74CBT3253): **Top side.** *Caution! Install with the polarity as shown above! Solder one pin, double check the orientation with the picture above, and then solder the rest of the pins.*

Install capacitor: **Top side** □ C86, 22 uf. *Caution! Install with black stripe as shown above!*

Install shorting strips: **Top side** □ C24, □ C25, □ C26, and □ C27. Install “U” formed wires to short out these unused caps as shown above.

Install resistors: **Top side** □ R4 (18 ohms – marked 180), □ R2 (300 ohms - marked 301)

Install 0.1 uf (no color code) capacitors: **Bottom side** □ C71, □ C85

Install 0.01 uf (Brown) capacitors: **Bottom side** □ C2, □ C3, □ C7, □ C8

Install resistors: **Bottom side** □ R1 (300 ohm – marked 301), □ R67 & □ R68 (3.3K – marked 332)

### ***Detector Circuit Tests***

Connect the 9v battery. After the keyer finishes sending “FB”, the board current draw when connected to the 9v battery will be in the 27 to 29 ma range.

Measure the voltage at either end of R4. Again, the ground reference for this test is the tab of the large 78M05 voltage regulator. The measured voltage should be in the 2.2 to 2.5v range. This test makes sure that the input voltage divider works.

Measure the voltage on the shorting strap of unused capacitors C24, C25, C26, and C27. If the detector is running correctly, the voltage at each of these points should be the same as seen across R4 above, 2.2 to 2.5v.

***Disconnect the 9v battery supply.***



## Receiver Audio Preamp

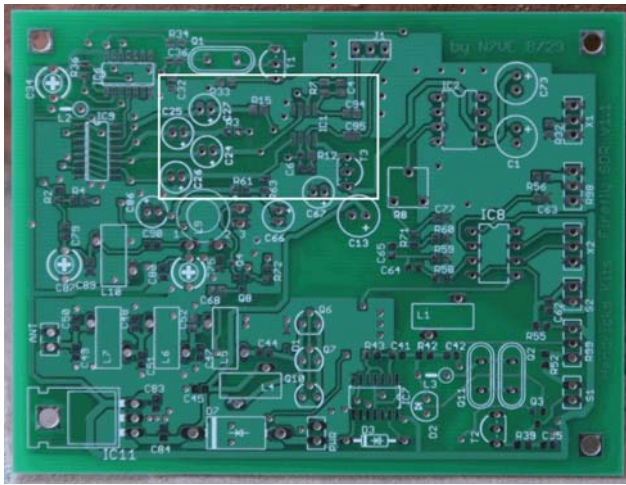

Figure 46. Top placement of receiver audio preamp stage

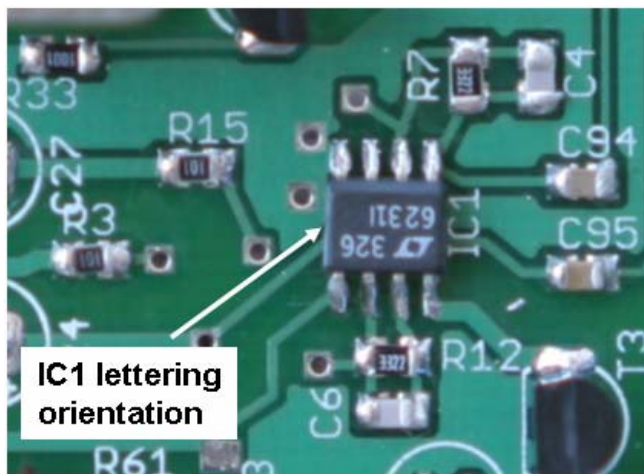

Figure 47. Close up of the parts in the audio preamp stage (top side only)

Install  IC1 (LT6231): **Top side.** *Caution! Install with the polarity as shown above! Solder one pin, double check the orientation with the picture above, and then solder the rest of the pins.*

Install capacitors: **Top side**  C4,  C6 (150 pf - Yellow) *Use the right pads! See the figure above!*

Install capacitors: **Top side**  C94,  C95 (0.1 uf – no color code)

Install resistors: **Top side**  R3,  R15 (100 ohms – 1% resistor marked 1000)

Install resistors: **Top side**  R7,  R12 (33k ohm – 1% resistor marked 3302)

## ***Receiver Audio Preamp Tests***

Connect the 9v battery. After the keyer finishes sending “FB”, the board current draw when connected to the 9v battery will be in the 33 to 35 ma range.

Measure the voltage at the IC1 end of C94 and C95. Again, the ground reference for this test is the tab of the large 78M05 voltage regulator. The measured voltage should be somewhere mid-range in the 0 to 5v range, perhaps as low as 1.5v and as high as 3.5v. The voltage should be closer to 2.2 to 2.5v after the receiver opposite sideband suppression is tuned up during the alignment section. The voltage should not be 0v or 5v on the IC1 end of C94 or C95.

Note that the DC voltage out of the pre-amp will shift based upon the tuning setting of the detector clock phasing network, C34 (upper right hand corner). If you have concerns on the op-amp output voltage, adjust this trip cap and watch the DC output shift around. This is the receiver picking up its own local oscillator signal as a DC offset voltage.

***Disconnect the 9v battery supply.***

## ***Receiver Front End and T/R Switch***

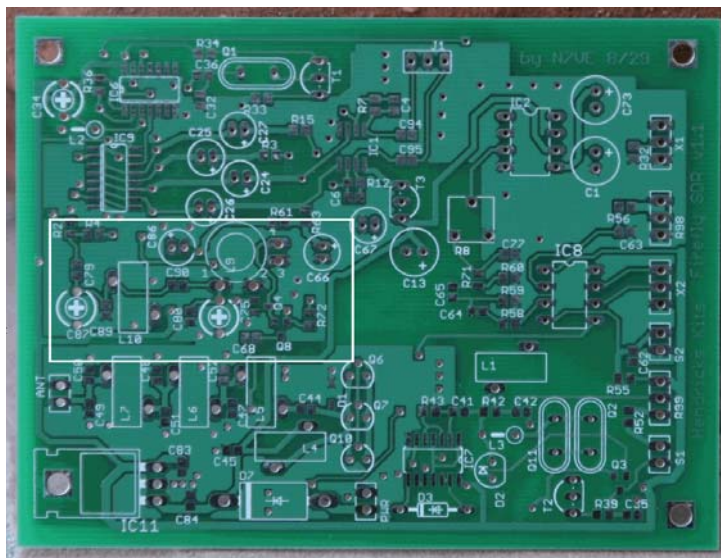

**Figure 48. Top placement of receiver front end and T/R switch**

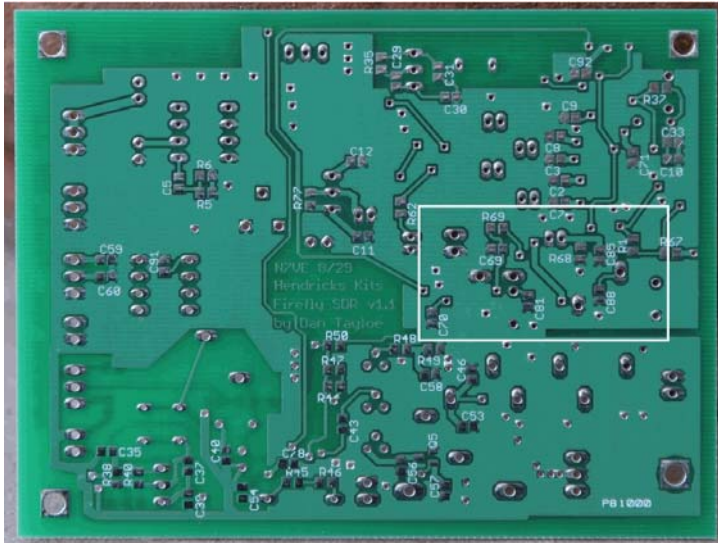

Figure 49. Bottom placement of receiver front end and T/R switch

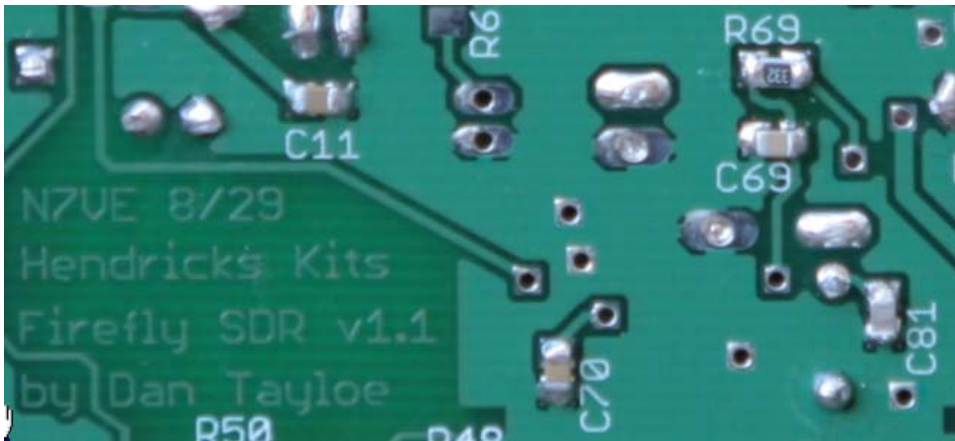

Figure 50. Close up of bottom T/R parts. R69, C69, C70 and C81

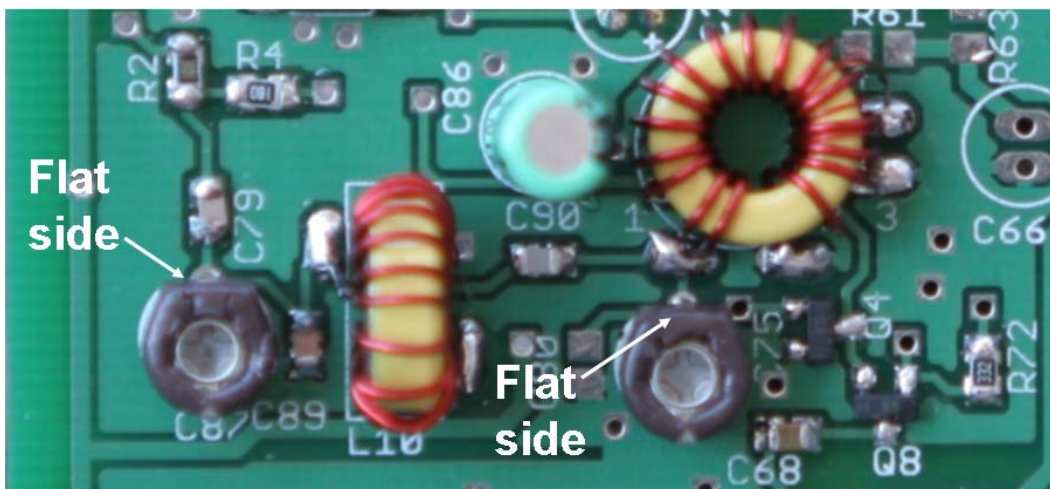

Figure 51. Close up of top side receiver front end and T/R switch



Install □ Q4 and □ Q8 (BSS123 – Blue in black package): **Top side**.

Install capacitors: **Top side** □ C68 (0.1 uf – no color code)

Install resistor: **Top side** □ R72 (3.3K – marked 332)

Install trimmer caps: **Top Side** □ C87, □ C75 50 pf trim cap. *Caution! Install flat side of trim caps as shown. These caps must have the right orientation or it will affect tune up (flat side hot end, rounded ground end).* See “Figure 40. Top side receiver LO parts mounted “ for an alternate style trim cap that may be in your kit..

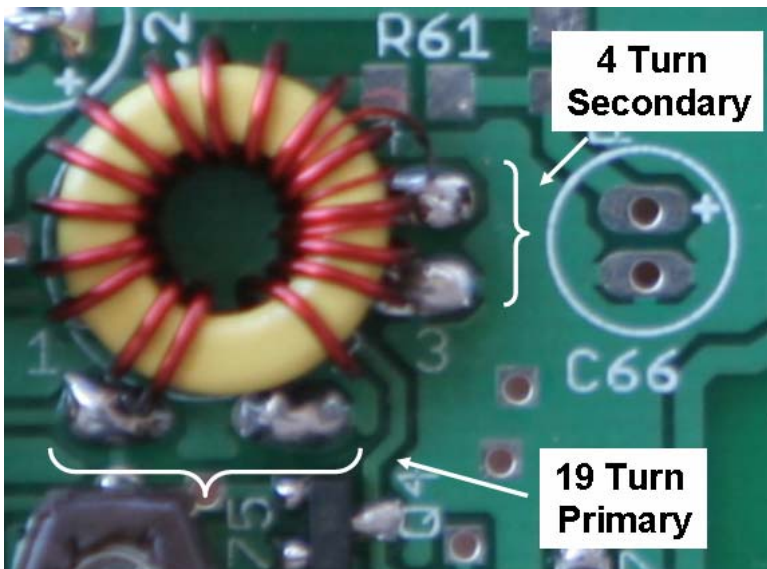

Figure 52. Close up of input receiver filter inductor L9. 30m values shown. For other bands see text.

*The wire used in this kit is especially designed to be easy to strip using heat.* Place some excess solder on the tip of your soldering iron (“solder blob”). Place the end of the cut wire into the blob, and the insulation will burn off. Work the iron down the wire to strip off as much insulation as needed, refreshing the solder blob as needed.

Install capacitors: **Bottom side** □ C69 & □ C70 (0.01 uf - Brown)

Install resistor: **Bottom side** □ R69 (3.3K – marked 332)

### 30m specific parts

**Bottom side** – □ C81 (180 pf – Orange)

**Top side** - □ C79 (47 pf - Red), □ C89 (150 pf - Yellow), □ C90 (7.5 pf – Orange/Black)

**Top side** - Install □ L9 - T37-6 yellow core, 19T # 26 primary, 4T #32 secondary. Use 10” of #26 wire (the larger diameter wire supplied in the kit) for the primary, 4” of #32 (the very fine diameter wire supplied) for the secondary.



**Top side - Install** □ **L10 - T37-6 yellow core, 18T # 26.** Use 10” of #26 wire (the larger diameter wire supplied in the kit) for the primary.

### 20m specific parts

**Bottom side –** □ **C81 (120 pf – Yellow/Black)**

**Top side -** □ **C79 (33 pf – Red/Blue), □ C89 (100 pf - Green), □ C90 (5 pf – Green/Black)**

**Top side - Install** □ **L9 - T37-6 yellow core, 15T # 26 primary, 3T #32 secondary.** Use 10” of #26 wire (the larger diameter wire supplied in the kit) for the primary, 4” of #32 (the very fine diameter wire supplied) for the secondary.

**Top side -Install** □ **L10 - T37-6 yellow core, 15T # 26.** Use 10” of #26 wire (the larger diameter wire supplied in the kit) for the primary.

### ***Receiver Front End and T/R Tests***

Connect the 9v battery. After the keyer finishes sending “FB”, the board current draw when connected to the 9v battery will be in the 33 to 35 ma range. The current drain should not have changed from the current drain measured in the previous section.

.There is not much that can be tested in this stage at this point. The drivers for the T/R switching transistors will not be installed until later. In past projects, there have been a lot of problems with the enamel wire on the inductors not being properly stripped before the inductors are installed. One simple test is to place an ohm meter across the PC board pads of L9 (two pads) and L10 (four pads) to ground (the tab of the 5v regulator) to make sure the inductor leads had been properly stripped and installed.

***Disconnect the 9v battery supply.***

## Transmitter VXO

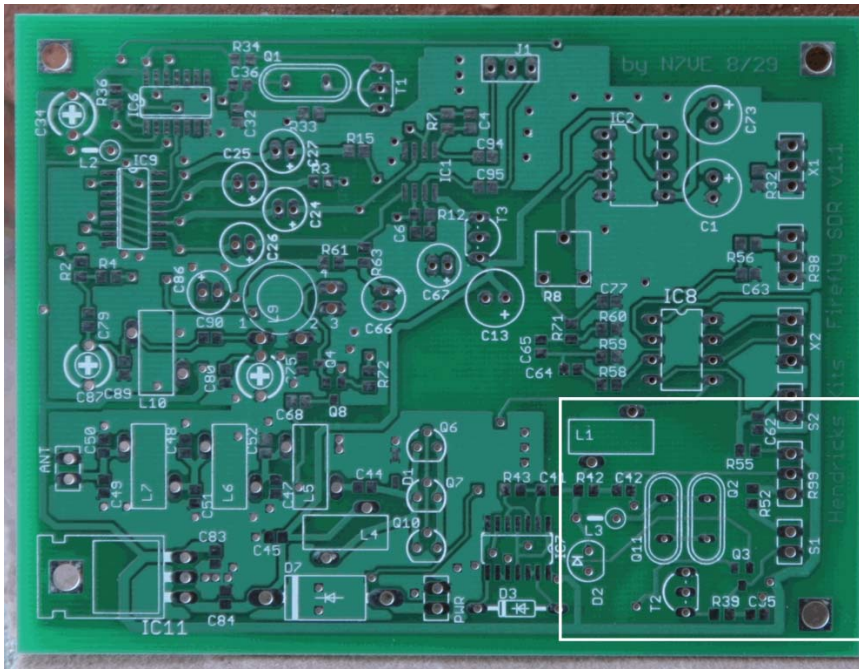

Figure 53. Top side location of the transmitter VXO

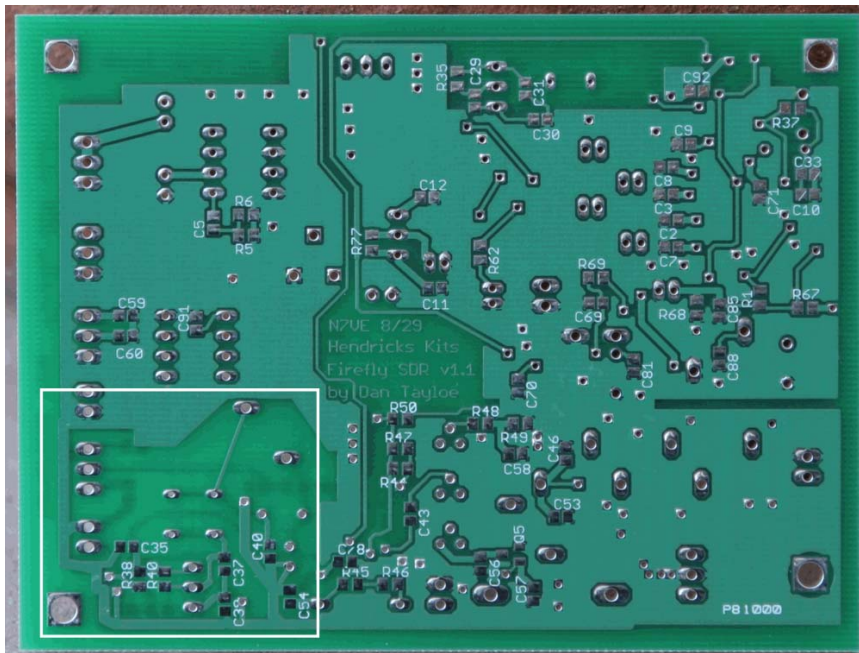

Figure 54. Bottom side location of the transmitter VXO

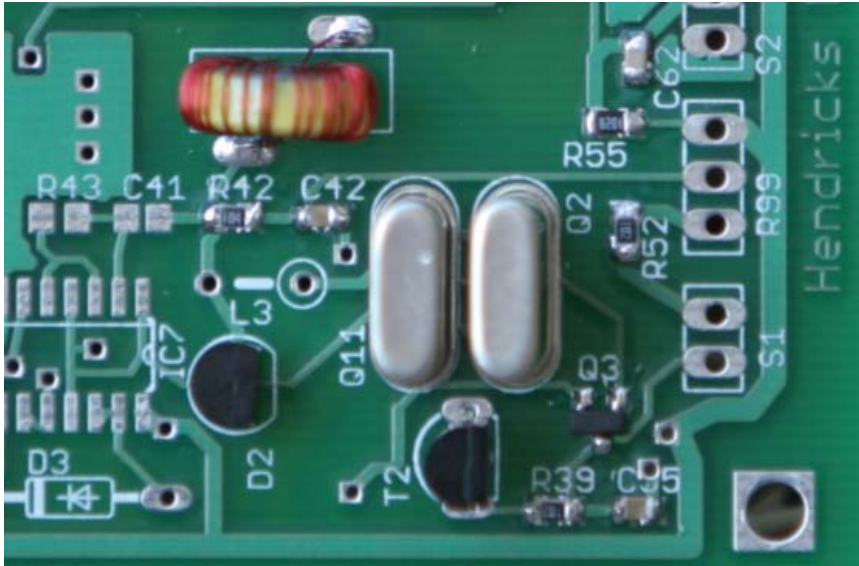

Figure 55. Close up of top side installed transmitter VXO parts

Install transistors: **Top side.** □ T2 (2N4401), □ Q3 (BSS123 – Blue in black package) **Caution! Install with the polarity as shown above!** The flat side of T2 matches the flat side on the silkscreen outline.

Install capacitors: **Top side** □ C55 & □ C42 (0.1 uf – no color code).

Install resistors: **Top side** □ R39 & □ R52 (1K – marked 102), □ R42 (100K – marked 104)

Install varicap tuning diode: **Top side** □ D2 (MV209). **Caution! Install with the polarity as shown above!** The flat side of D2 matches the flat side on the silkscreen outline.

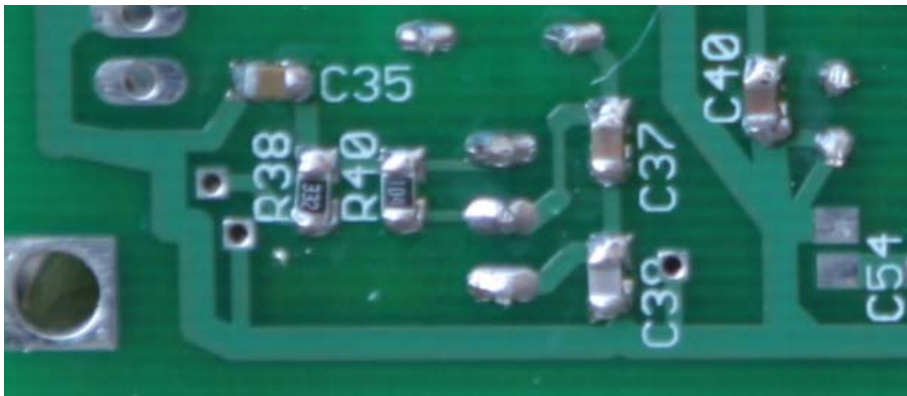

Figure 56. Close up of the bottom side installed transmitter VXO parts

Install capacitors: **Bottom side** □ C35 (0.1 uf – No color code), □ C40 (22 pf – Red/Black)

Install resistors: **Bottom side** □ R40 (100K ohm – marked 104), □ R38 (3.3K – marked 332)

### 30m specific parts

**Bottom side – Install capacitors:**  C37 (100 pf - Green),  C38 (180 pf - Orange)

**Install crystals: Top side**  Q2,  Q11 (10.116 MHz)

**Install inductor: Top side**  L1 - T37-6 yellow core, 56T #32. Use the #32 wire (the very fine diameter wire supplied).

### 20m specific parts

**Bottom side – Install capacitors:**  C37 (68 pf – Blue/Black),  C38 (150 pf - Yellow)

**Install crystals: Top side**  Q2,  Q11 (14.060 MHz)

**Install inductor: Top side**  L1 - T37-6 yellow core, 40T #32. Use the #32 wire (the very fine diameter wire supplied).

**Note: L1 needs to be coated with clear fingernail polish to both seal the windings to the core and seal the core to the board.** Not all clear fingernail polishes dry hard. My wife recommends **Sally Hansen Diamond Strength** (source: Ulta). It seems to work very well. Sealing windings to the core improves the temperature stability of this oscillator.

### *Transmitter VXO Tests*

Connect the 9v battery. After the keyer finishes sending “FB”, the board current draw when connected to the 9v battery will be in the 33 to 35 ma range. The current drain should not have changed from the current drain measured in the previous section. Shorting S1 (TX VXO spot switch) should see the current drain increase by another 1 ma.

At this point in time, there will be no voltage across D2, the varactor tuning diode, so the VXO will be tuned to a very low frequency. Thus you can verify that the VXO is oscillating by listening for the transmit VXO as the jumper header S1 is shorted. The VXO frequency might end up being lower than 10.1 MHz (30m version only)

***Disconnect the 9v battery supply.***



## Transmitter Buffer Circuit

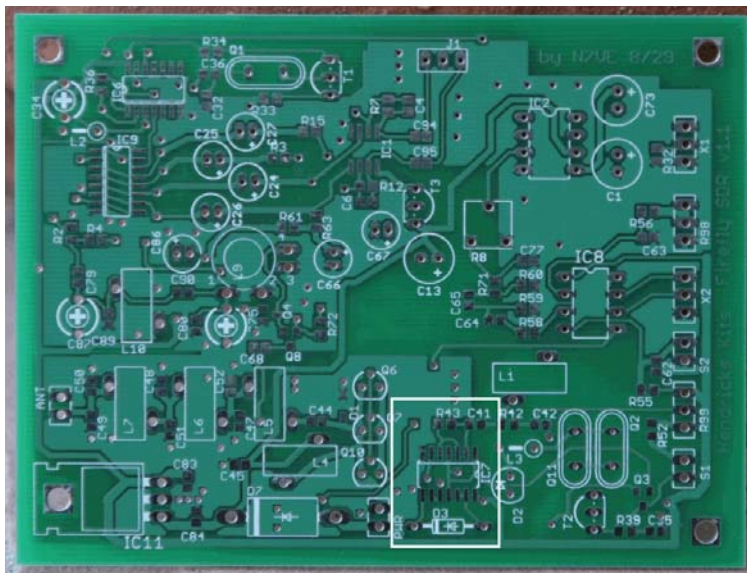

Figure 57. Top side location of the TX Buffer circuit

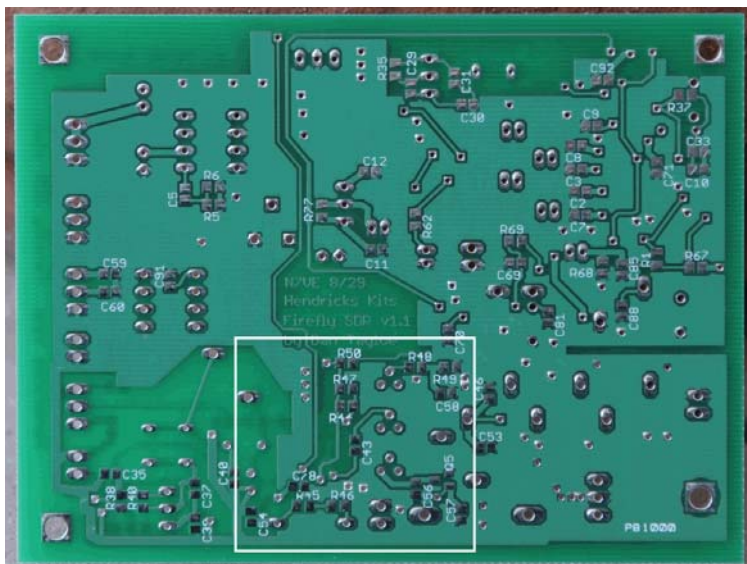

Figure 58. Bottom side location of the TX buffer circuit.

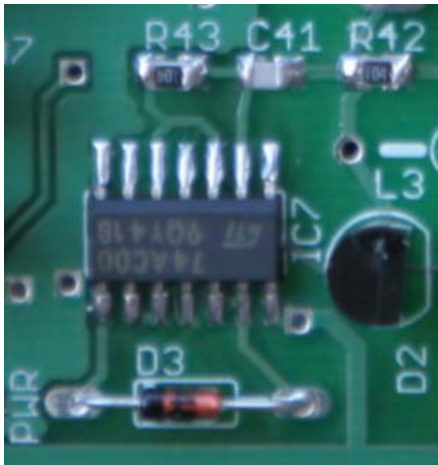

Figure 59. Top side TX buffer parts installed. IC7, D3, R43, C41

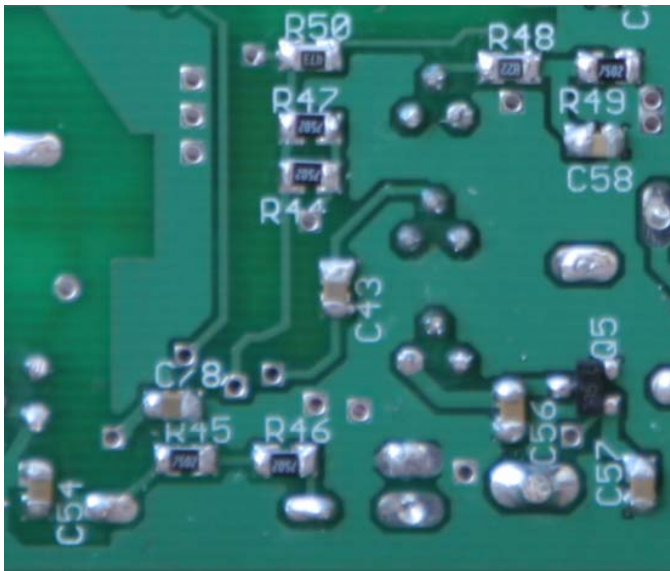

Figure 60. Bottom side TX buffer with parts installed

Install IC: **Top side.** □ IC7 (74AC00) *Caution! Install with the polarity as shown above! Solder one pin, double check the orientation with the picture above, and then solder the rest of the pins.*

Install capacitor: **Top side** □ C41 (5 pf – Green/Black).

Install resistor: **Top side** □ R43 (100K – marked 104)

Install diode: **Top side** □ D3 (1N4148)

Install capacitors: **Bottom side** □ C54, □ C78, □ C43, □ C56, □ C57 (0.1 uf – no color code)

Install capacitors: **Bottom side** □ C58 (0.01 uf - Brown)

Install resistors: **Bottom side** □ R45, □ R46, □ R44, □ R47, □ R49 (75K ohm – marked 753)

Install resistors: **Bottom side** □ R50 (47K ohm – marked 473), □ R48 (8.2K ohm – marked 822)

Install transistor: **Bottom side** □ Q5 (FDN335 – Red in Black package)

### *Transmitter Buffer and T/R Switch Tests*

Connect the 9v battery. After the keyer finishes sending “FB”, the board current draw when connected to the 9v battery will be in the 33 to 35 ma range. The buffer stage draws basically no additional current when not transmitting.

At this point, the drivers for the T/R switch have been put into place so that the T/R switch can now be tested. Refer to the figure below:

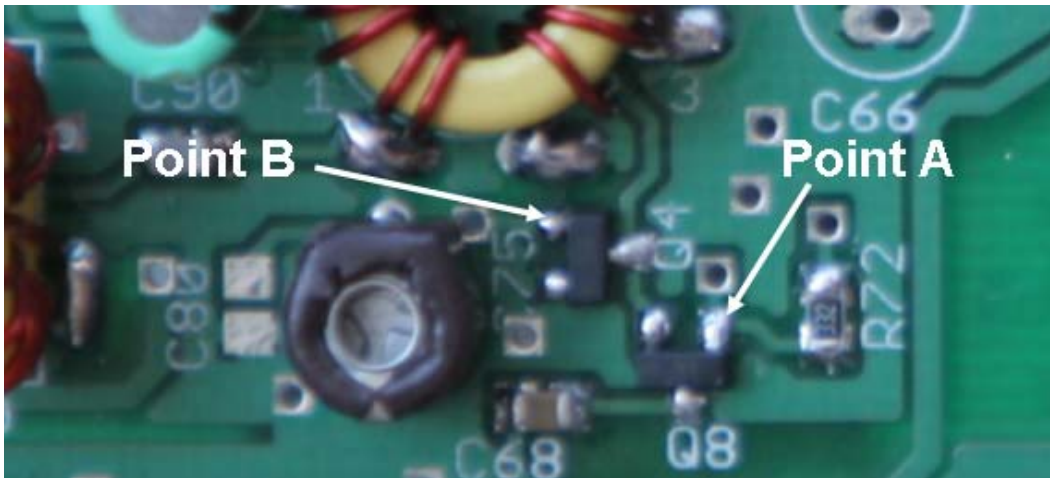

**Figure 61. Top side test points for the T/R switch in the receiver front end**

With the board powered up in receive mode, **point A should be 5v**, and **point B should be 0v** or at least less than 1v. When in transmit mode, these readings should flip: point A 1v or less and point B at 5v. The T/R transition can be tested by shorting the keyer paddle inputs as shown in the diagram below:

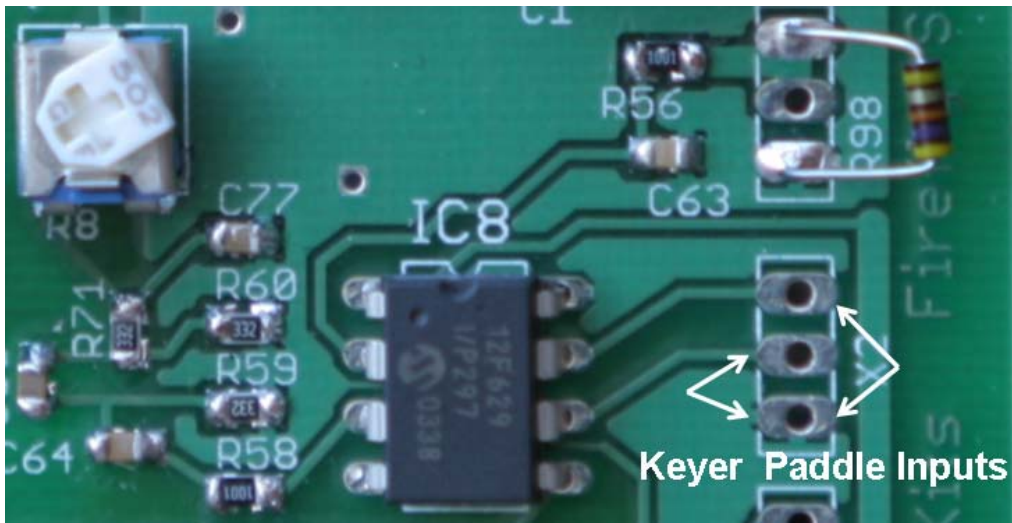

Figure 62. Location of keyer paddle inputs to test the T/R switch

I typically use my pointed tweezers to temporarily short the paddle inputs for a quick test.

*Disconnect the 9v battery supply.*

***Transmitter PA Circuit***

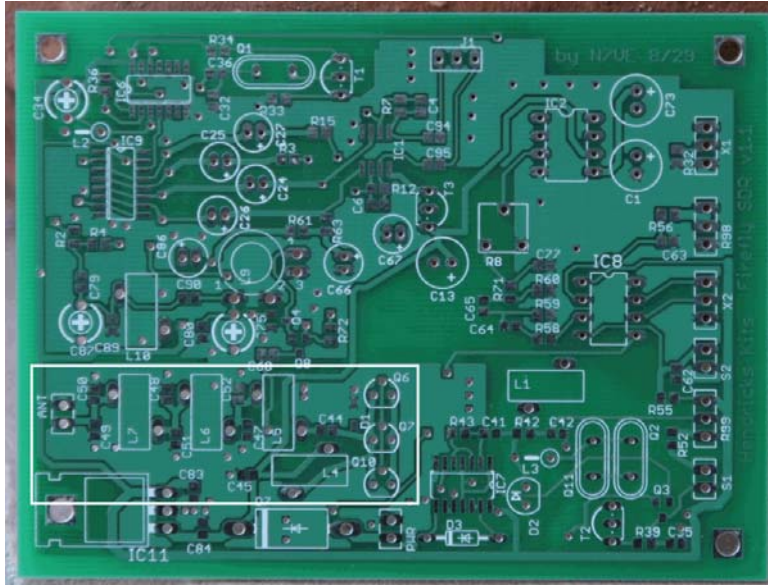

Figure 63. Top side view of the PA circuit



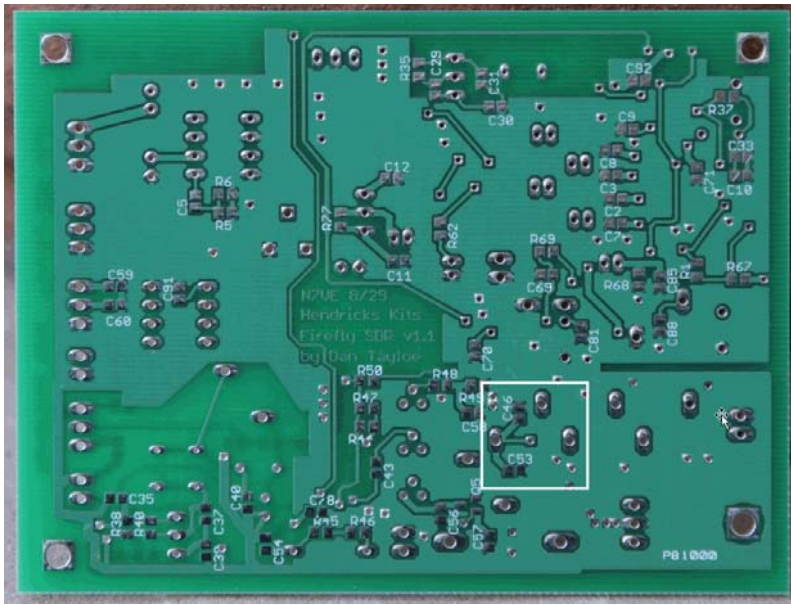

Figure 64. Bottom side view of the PA circuit

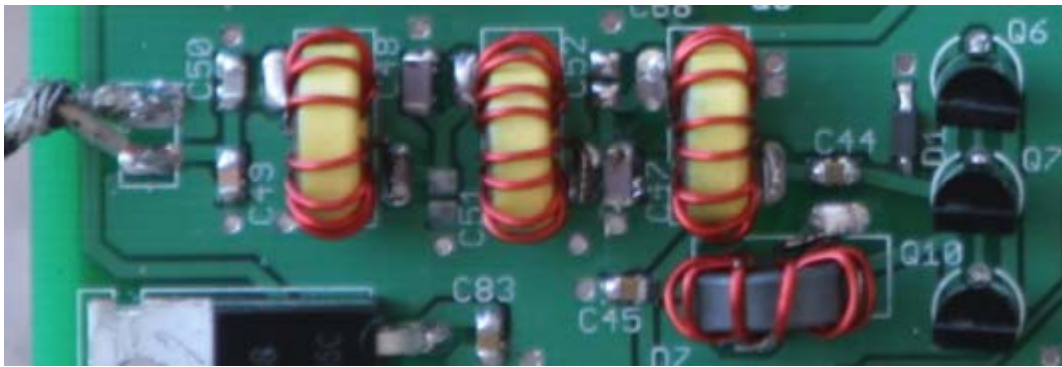

Figure 65. Top side parts view of the PA circuit. C50 (left top end cap) not used on the 30m version.

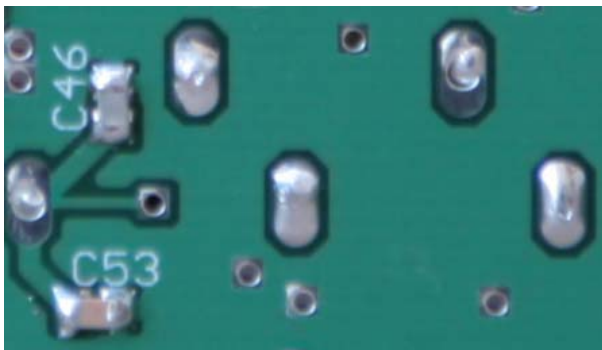

Figure 66. Bottom side part view of PA circuit. C53 not used in the 30m version

Install diode: **Top side** □ D1 (51v Zener Diode – No color code. Single item in black package). *See figure below! Double check band orientation!*

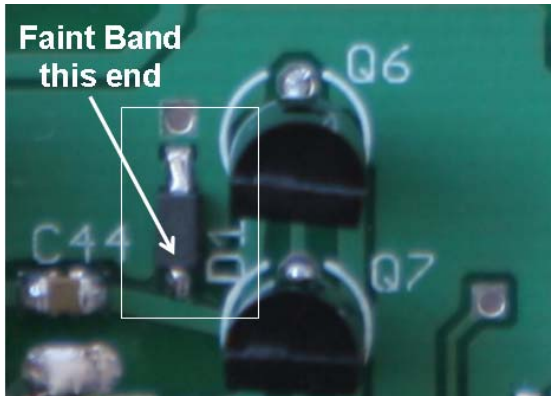

Figure 67. Close up of Zener diode D1 with band orientation

Install transistors: **Top side** □ Q6, □ Q7, and □ Q10 (BS170). *Double check flat side transistor orientation in above figures!*

Install capacitor: **Top side** □ C44, □ C45 (0.1 uf – No color)

**30m specific parts**

**Install capacitor: Top side** □ C47 & □ C48 (470 pf - Blue), □ C49 (180 pf - Orange)

**Install capacitors: Bottom side** □ C46 (180 pf - Orange)

*Note: make sure the windings on the following inductor are evenly spaced over the entire core!*

**Install inductors: Top Side** □ L5 & □ L7 - T37-6 (yellow core) 16T #26 - 10” of wire

**Install inductors: Top Side** □ L6 - T37-6 (yellow core) 18T #26 - 10” of wire

**Install inductors: Top Side** □ L4 - FT37-43 (dark core) 10T #26 - 10” of wire

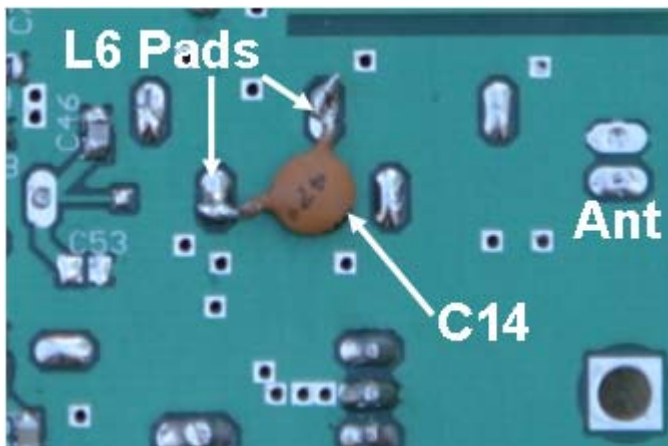

Figure 68. Location of 20m modification, C14. Bottom side of TX low pass filter L6.

### 20m specific parts

Install capacitor: Top side □ C47 & □ C48 (330 pf – Red/Yellow), □ C49 (150 pf - Yellow)

Install capacitors: Bottom side □ C46 (150 pf - Yellow), □ C14 (47 pf disc cap – see figure above)

*Note: make sure the windings on the following inductor are evenly spaced over the entire core!*

Install inductors: Top Side □ L5 & □ L7 - T37-6 (yellow core) 13T #26 - 10” of wire

Install inductors: Top Side □ L6 - T37-6 (yellow core) 14T #26 - 10” of wire

Install inductors: Top Side □ L4 - FT37-43 (dark core) 8T #26 - 10” of wire

**Note: The use of C14 on 20m seems to have boosted the output power from 2.5 to 3.5w.**

### *Transmitter PA Tests*

Connect the 9v battery. After the keyer finishes sending “FB”, the board current draw when connected to the 9v battery will be in the 33 to 35 ma range.

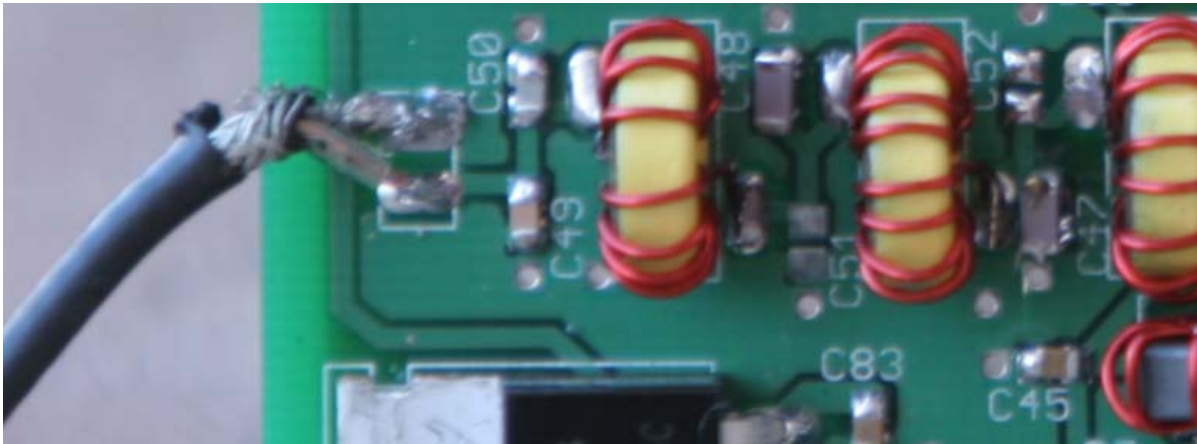

Figure 69. Antenna coax connection to transceiver. Upper connection is ground, lower is antenna.

Connect a coax to the board and connect the transceiver to a 50 ohm load. Switch the 9v battery for a more stout 12v power source. Keying the transmitter as in the previous section should produce a 2.5w output.

## Board Connections

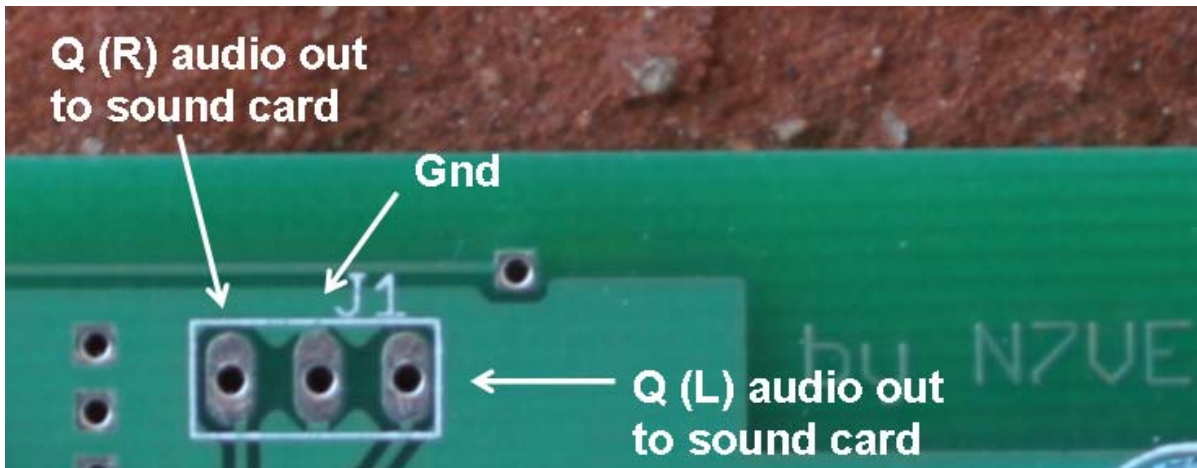

Figure 70. Connections for J1, I/Q (R/L) audio output to the PC sound card input

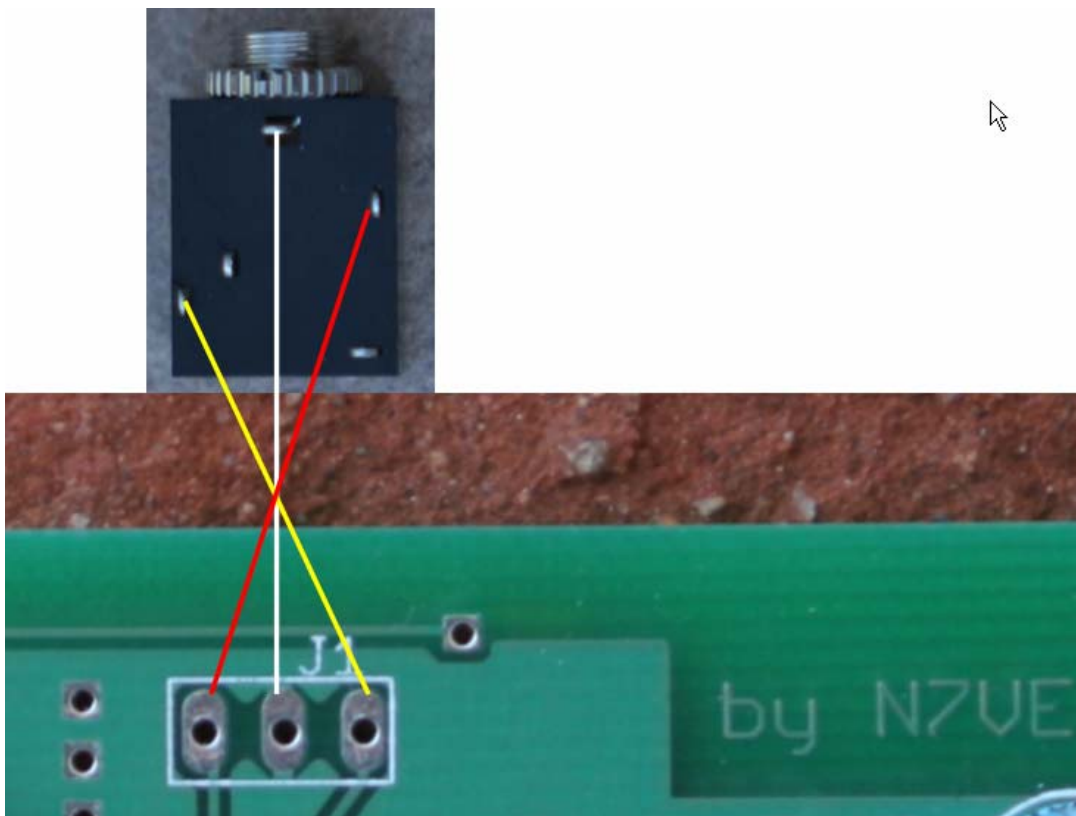

Figure 71. Connections of the I/Q audio output to its audio jack



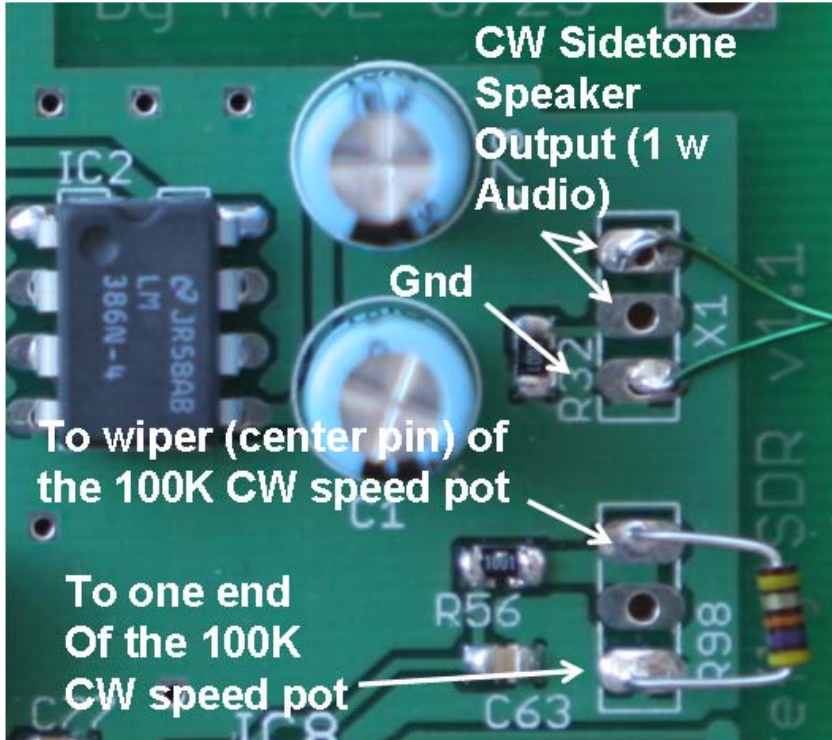

Figure 72. Connections for X1 and R98, CW side tone monitor speaker and 100K CW speed pot.

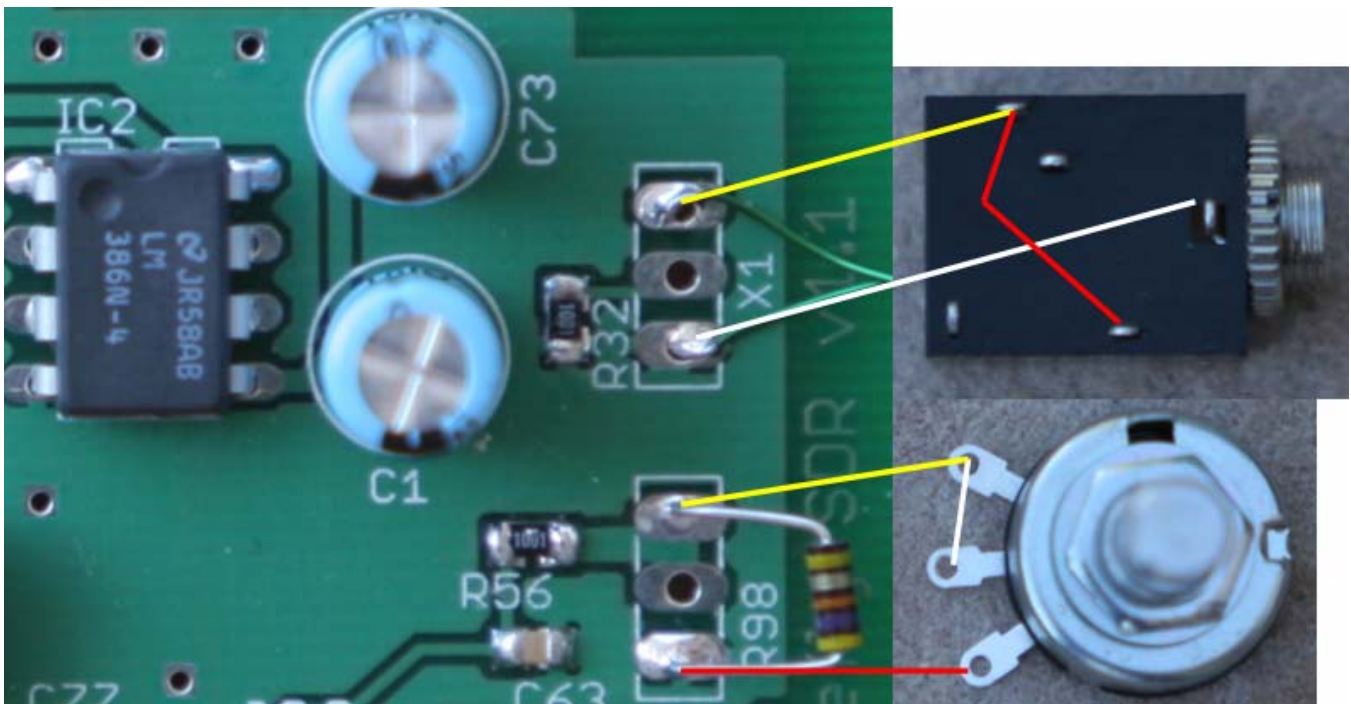

Figure 73. Connections to CW mon speaker jack, CW speed pot. Remove temporary resistor across R98.

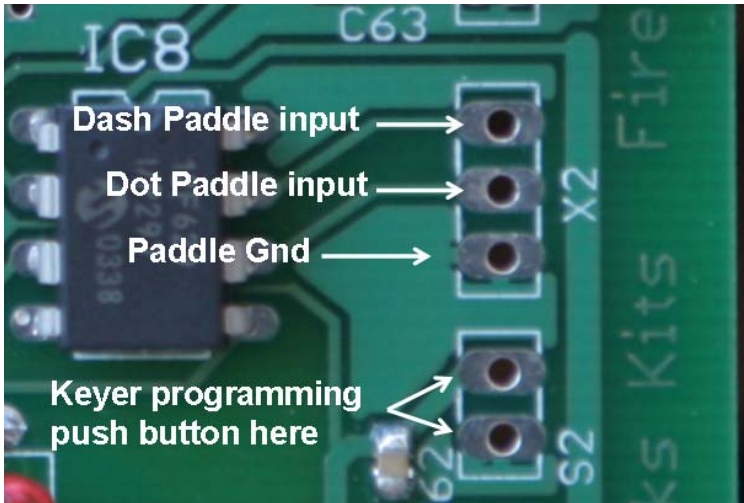

Figure 74. Connections for keyer paddle inputs (X2) and for keyer programming push button switch (S2)

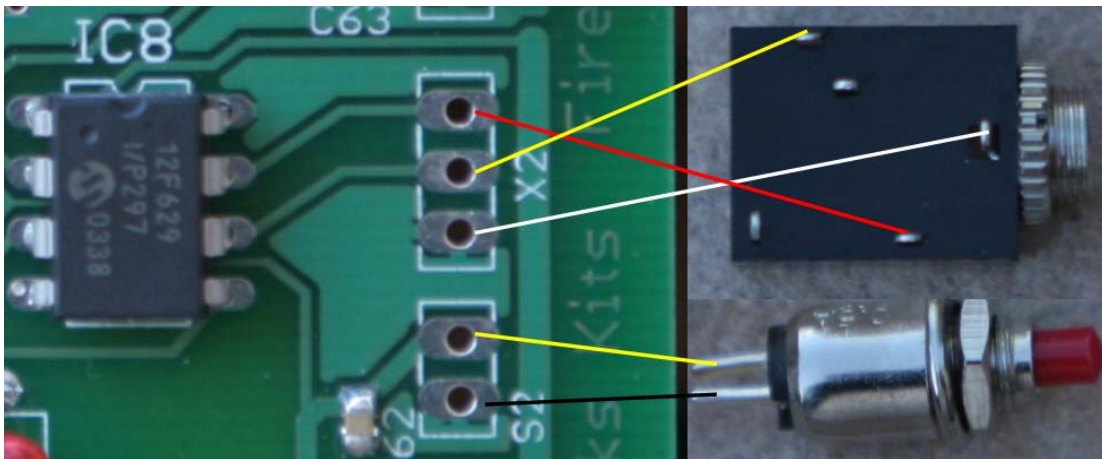

Figure 75. Visualization of paddle jack and keyer programming switch connections

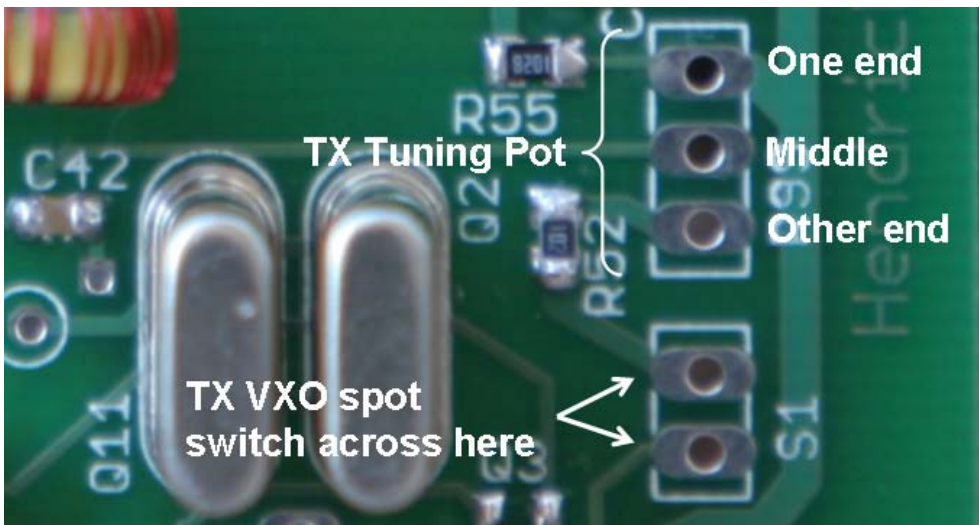

Figure 76. Connections for TX spot switch (S1) and TX VXO 10K tuning pot (R99).



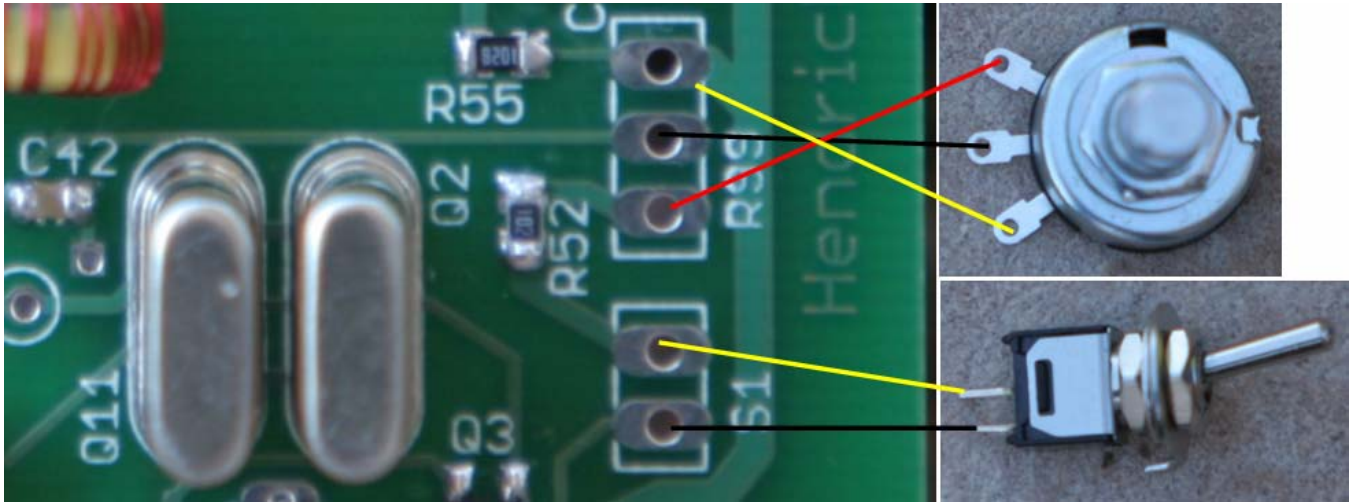

Figure 77. Visualization of TX tuning pot and VXO spot switch connections. Switch shown “Spot On”.

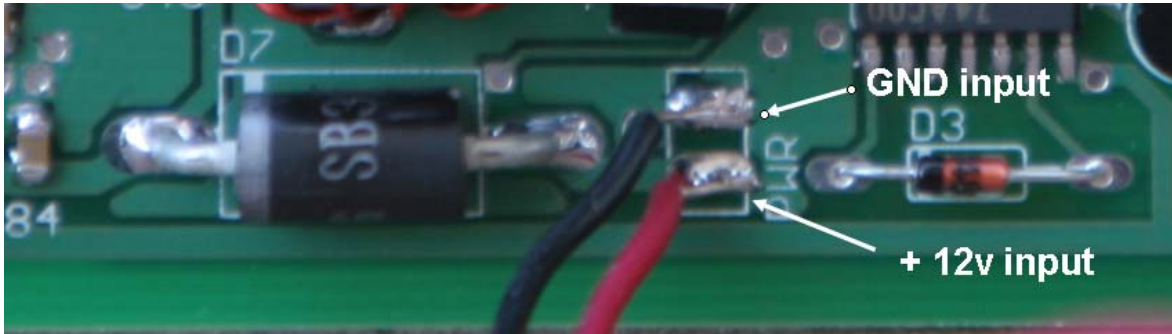

Figure 78. Connections for 12v to the board

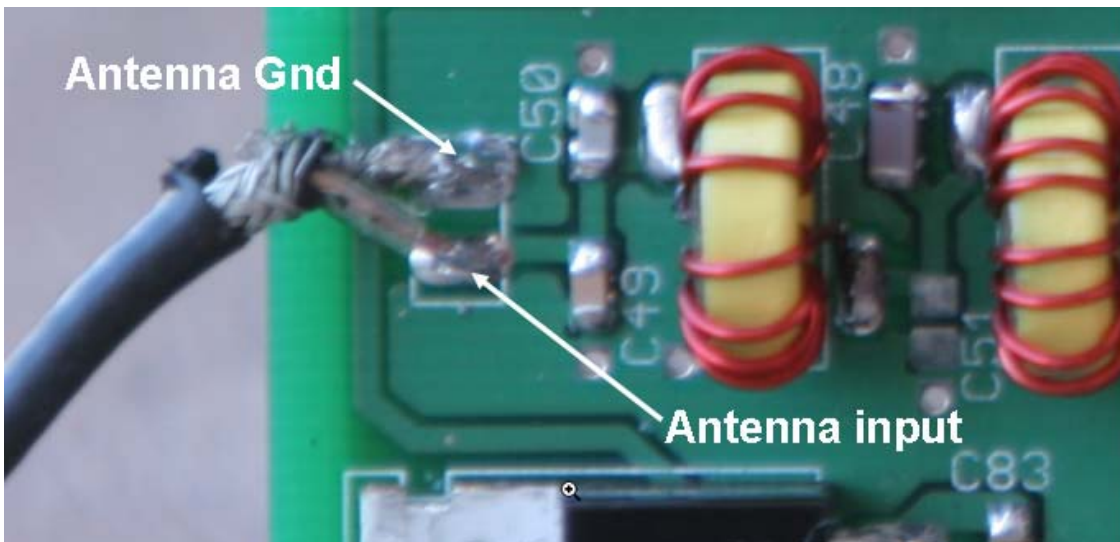

Figure 79. Antenna Connections

*System Connection Block Diagram*



Figure 80. External connections from a case view

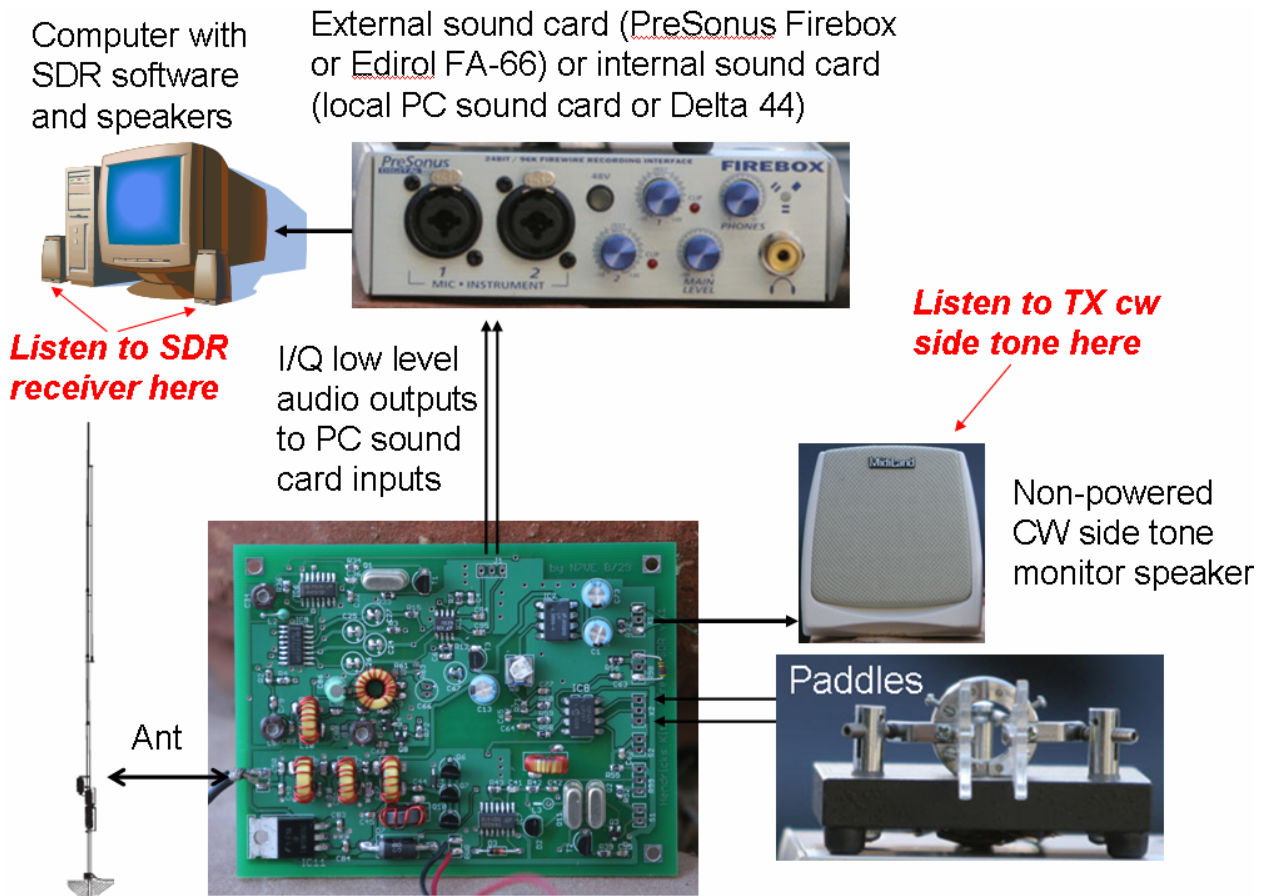

Figure 81. Diagram of the major external interfaces of the Firefly SDR, less front panel controls.



## *Mounting into a case*

Transmitter section to the rear side of the case, CW sidetone monitor speaker outputs to the front. The holes in the board (and in the 78M05 5v regulator) are sized for 4-40 hardware. I recommend using either one thick nut as a spacer between the case and the board (as shown below) or two regular nuts.

***Do not use over size nuts! Before mounting, make sure the nuts used are not so wide as to short out any traces to ground on either the top or bottom side of the board.***

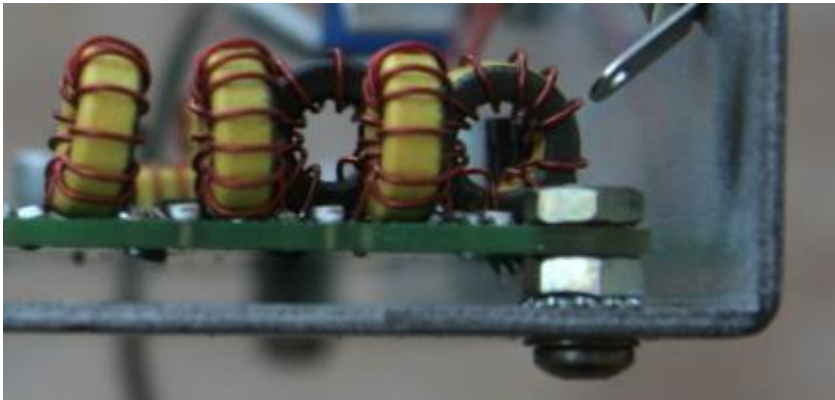

Figure 82. Mount all four corners of the main board using the mounting hardware as shown.

The board is 3.2" x 4.2". The antenna jack should be placed as close as possible to the rear of the case, while the other connections such as TX VXO tuning, cw speed, etc, should be placed near the front. ***A minimum case length of 5" is recommended in order to provide some space for front mounted jacks and pots. The case should be at least 3.25" wide. The case should be at least 1 3/8" high in order to allow room on the front panel for a larger tuning knob.***



Figure 83. Homebrew case fashioned out of double sided PC board, 5" x 3.5" x 1.375".

## ***A Note on PC Sound Cards***

The SDR receiver front end puts out very low level audio signals in the 0 to 24 KHz range that is converted into digital form by the sound card of a computer. It is good to keep in mind that the sensitivity of the SDR receiver relates directly to the performance of the sound card A/D converter. Generic PC sound cards use 16 bit A/D converters. All A/D converters have a maximum input voltage of around 2 to 5v. The performance of 16 bit converters are typically roughly 80 db of dynamic range. Pro sound cards use 24 bit converters which are in the 98 to 122 db. The currently affordable high end 24 bit cards are in the 108 to 112 db of dynamic range, which is 30 db more sensitivity than the 16 bit card. The very high end 122 db A/D parts currently exist, are being designed into a sound card that should be available in a few months by the HPSDR group and TAPR.

The point of all of this is that the large signal dynamic range and the receiver sensitivity is a function of the quality of the A/D converters. The 16 bit sound card in most PCs will not allow the full receiver performance to be realized. However, it will allow the user to get on the air, make contacts, and give SDR receivers a trial spin before moving on to a better sound card.

The current higher end sound cards are the Delta-44 (\$150, designed for a desktop PC) and the Edirol FA-66 (\$350, designed for a firewire interface to a laptop). Flex Radio carries these sound cards:

<http://www.flex-radio.com/>

It needs to be noted that most laptops are reported not to have stereo sound card inputs, but rather mono inputs. If the receiver is connected to a mono input, the SDR software will work, but will be unable to determine the difference between a signal 1 KHz higher from the center 10.114 MHz from that 1 KHz lower than 10.114 MHz. Thus signals that appear at 10.108 MHz (10.114 – 6 KHz) could really be a signal at 10.120 MHz (10.114 + 6 KHz). The use of the both the I/Q outputs from the receiver allows the SDR software to determine which side of 10.114 MHz the signal belongs to and to null the image.

## ***Pre-Loading of SDR software on the PC***

In order to tune up the receiver, the I/Q audio output must be connected to the sound card input of a PC and a SDR software package must be installed and verified. There are several SDR software packages that are very popular, “Rocky” and “PowerSDR”. Both are free and are available on line.

Of the two, I think that PowerSDR that has seen the most development activity, and is what I recommend. Remember that since the vast majority of the receiver functionality is in software, improvements to SDR software is like getting receiver hardware upgrade for free. For example, PowerSDR just release a beta version that allows two receivers to be run at the same time, one in the right speaker, the other in the left. This allows one to listen to both sides of a DX pile up when operating a split, or allows to monitor a station you want to work while you tune around elsewhere in the band.

Both Rocky and PowerSDR are set up to work with softrock receiver. The receiver portion of this rig is softrock compatible. Any SDR software that can run a softrock receiver can be used for the receiver side of the Firefly SDR.

Rocky: <http://www.dxatlas.com/rocky/>

This page for Rocky gives the setup instructions for the Rocky software package.

PowerSDR: <http://www.flex-radio.com/testdrive.htm>

This gives a link for you to get the PowerSDR software up and running on your computer. If you have any question on whether or not your computer is fast enough to run SDR software, I would suggest running this and checking the CPU meter on your computer. One of the features of both Rocky and PowerSDR is that it allows you to run a prerecorded sound file. Note that playing a prerecorded sound file exercises the full receiver functionality since the receiver cannot tell the difference between sound samples from the sound card from sound samples played from a file. If the sound samples work, your computer will work.

<http://www.flex-radio.com/downloads.htm#PowerSDR> This link includes one sound file. Use this for a test drive of both Rocky and PowerSDR.

There is no reason why you cannot install both packages on your computer and try them both out.

The computer requirements vary widely from computer to computer. In general, any computer with a video on the mother board will have much worse performance than a computer with dedicated video card. It is much cheaper for a computer manufacturer to use an integrated video chip set on the motherboard (almost all laptops are this way, as well as the low end desktops), but the video memory, which is used all the time for refreshing the display, is shared with the computer, thus the computer runs slow compared to the same computer with a dedicated video card.

The suggestions that I have seen recommend at least a 1 GHz PC. This should get you going for the standard +/- 24 KHz (48 kbps sampling rate) receiver reception range. There are sound cards available that also support 96 Kbps sampling (+/- 48 KHz receiver tuning range) and even 192 Kbps (+/- 96 KHz receiver tuning range). Flex Radio recommends a 3 GHz PC when sampling at 192 Kbps.

Keep in mind that the +/- 24 KHz tuning range of the receiver exceeds the tuning range of the VXO transmitter, so this does not really concern this kit. However, if you are looking to get a new computer, the 3 GHz rate would be one to keep in mind.

## Notes on loading PowerSDR

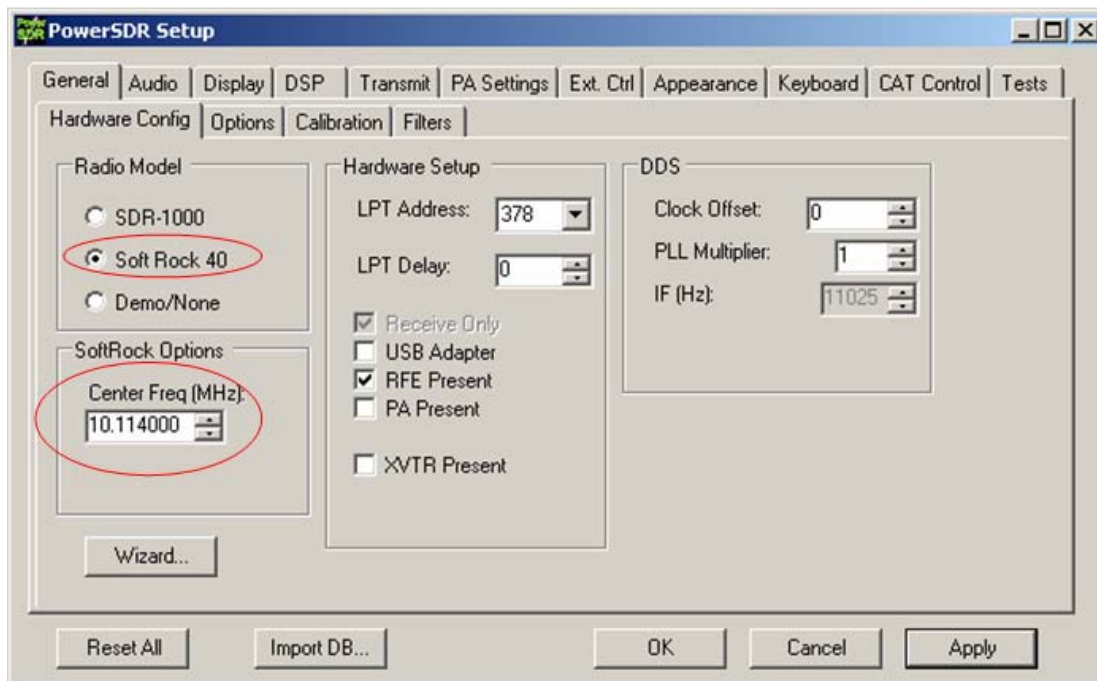

Figure 84. Select the setup tab to get to this window. Select SoftRock, and set the center frequency.

The nominal center frequencies are 10.114, 14.058, or 18.095 MHz. If you are using a signal source of a known signal level (like the KX1/KX2 generators), select the calibration tab above.

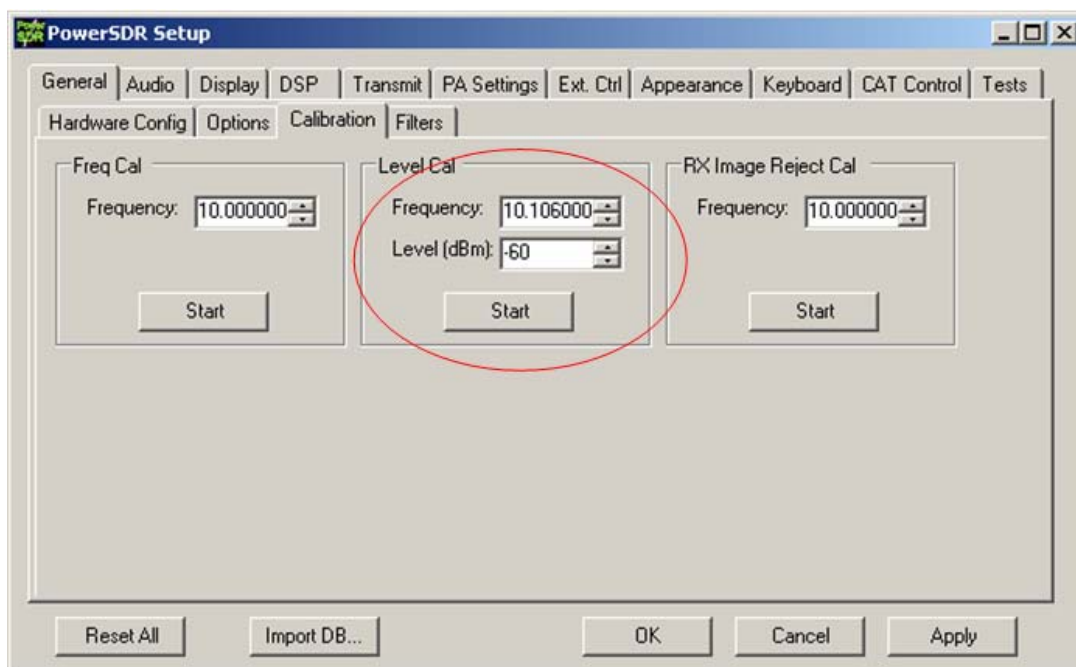

Figure 85. Sheet used to calibrate the signal strength readings in Power SDR



Enter the frequency of the test signal, its input signal strength, then click start.

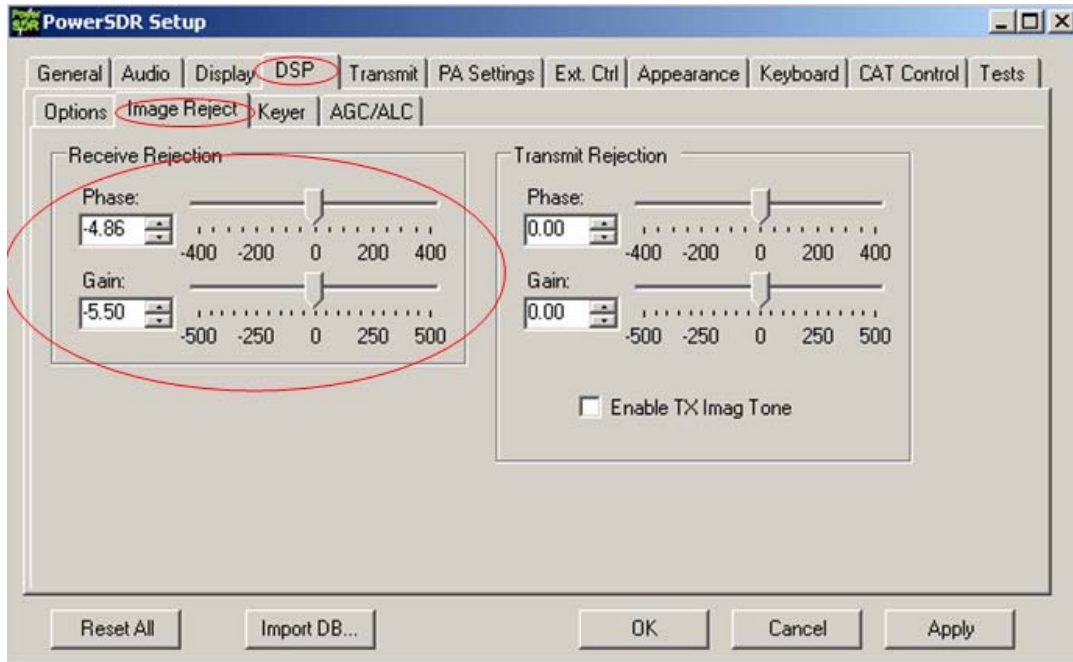

Figure 86. DSP/Image Reject tab used to null opposite sideband signal

This is the tab that is used to fine tune the image rejection response. Course tune using the sliders, then fine tune with the up arrow/down arrow on the box. Ideally, the rejection should be nulled using a signal ~ 5 KHz lower than the center frequency (10.114, 14.058, 18.095 MHz).

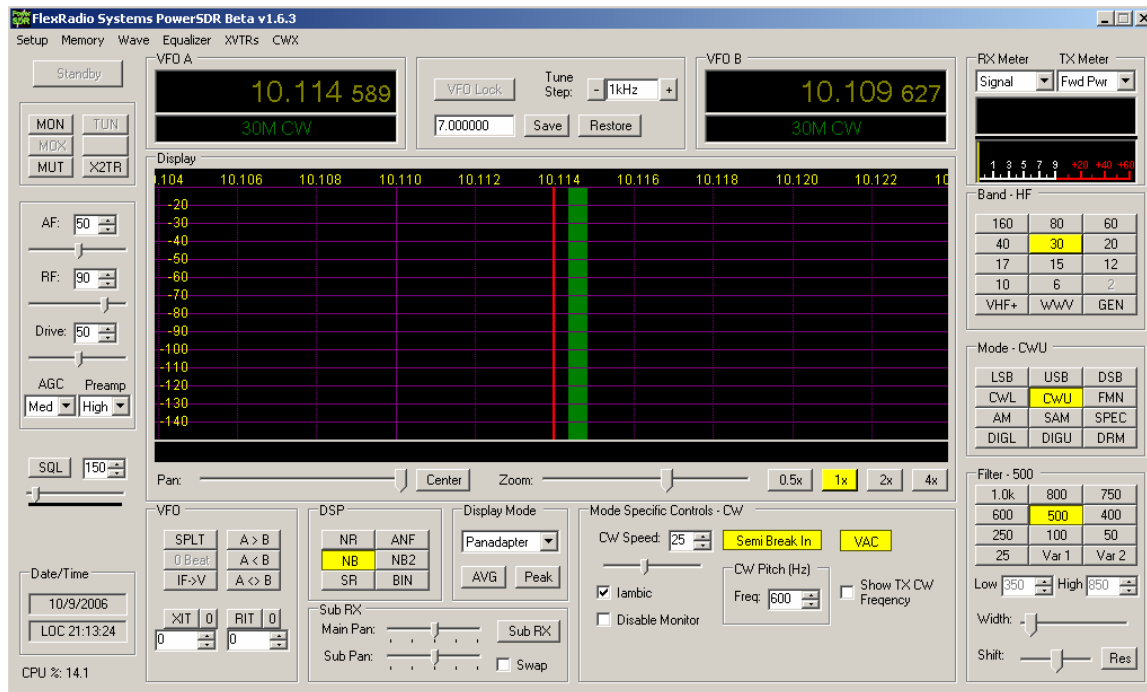

Figure 87. Generic settings – NB on, 500 Hz filter, CWU, proper band selected (30m here)

The most important point here is to click on “NB” to enable the noise blanker. Also note that the receiver will not turn on until the “Standby” button in the upper left is clicked (off as shown).

### ***SDR Receiver Resources***

If you have problems with the above packages, there are two user groups that have very knowledgeable folks that can probably help.

<http://groups.yahoo.com/group/softrock40/>

This is the softrock receiver group. Since the receiver used here looks like a softrock receiver (i.e., I/Q audio into a sound card), this group is a very good resource for hardware and software issue.

<http://mail.flex-radio.biz/pipermail/flexradio> [flex-radio.biz/](http://flex-radio.biz/)

This is the group for the PowerSDR software. If you use this package, you should probably monitor this group for software upgrades. Although this group is primarily focused on the Flex Radio SDR-1000, since their software is compatible with the softrock, it is also compatible with the receiver side of the Firefly SDR.

## Receiver Tune Up

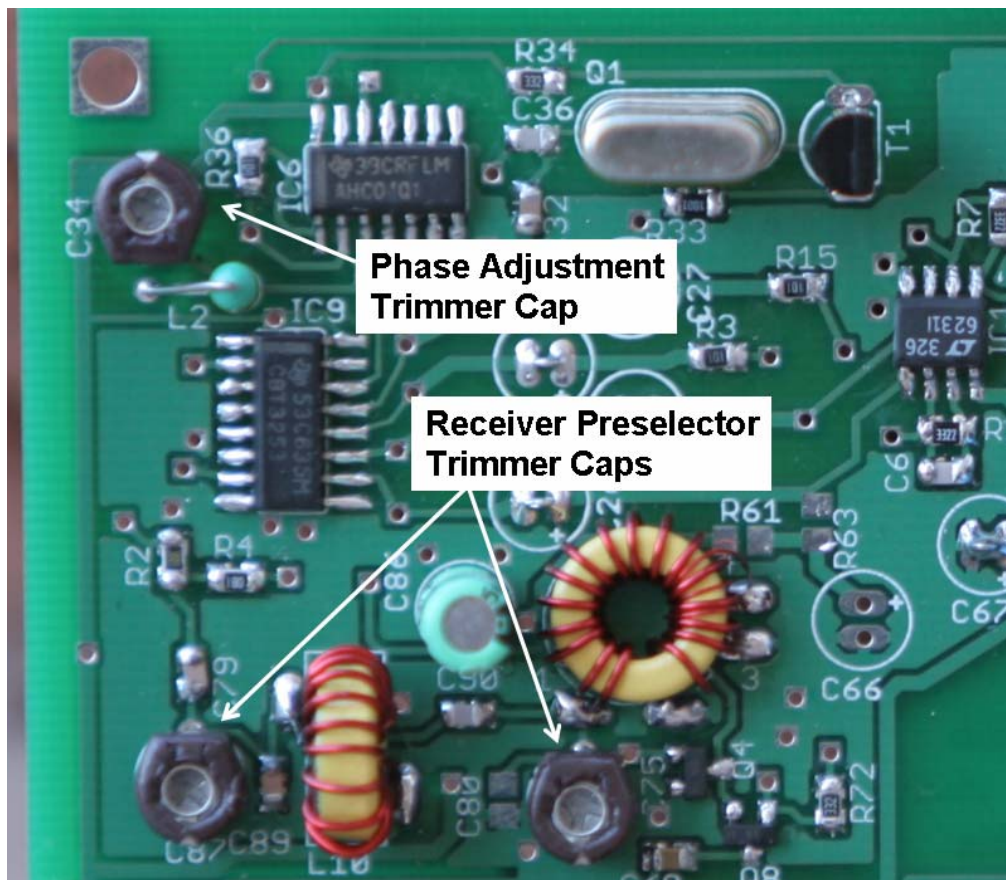

Figure 88. Adjustment points for tuning up the receiver.

The adjustment is very straight forward. First a strong, steady signal source is required. Some examples of signal sources are:

- A RF signal generator. For this purpose, a setting of  $-50$  dbm is ideal.
- A crystal oscillator loosely coupled into the front end (1 to 2 pf in series). QRP crystals are available from a number of sources including Norcal.
- A marker generator such as the one available from Norcal.
- A QRP transmitter transmitting at minimum power into a dummy load produced a very strong signal that can be readily picked up using a 1 inch “sniffer” stub of wire connected to the antenna port of the NC2030. ***DO NOT TRANSMIT DIRECTLY INTO THE FRONT END OF THE RECEIVER!***
- Over the air signals can be used, but these are usually neither strong nor consistent.

The first step is to peak the receiver preselector trim pots. With the receiver connected to the PC and with the SDR sound card connected, the receiver center frequency is roughly 10.114 MHz. This center frequency can be applied to the set up portion of the SDR software.

With one of the above signals applied to the input, the receiver Preselector trim caps are adjusted for best received signal strength. Alternating back and forth between the two caps quickly peaks the receiver front end.

The next step is to look at the tune up signal and its mirror image on the far side of 10.114 MHz. For example, if the target signal is 10.110 MHz, there will be an image of this signal at 10.118 MHz. First check to see which signal is smaller. There should be some small opposite sideband suppression at this point. If the 10.110 signal is larger, all is well. If on the other hand if the signal at 10.118 MHz is larger, then the I and the Q signals are backwards and need to be reversed.

If all is well, the opposite sideband image should be nulled out as much as possible using phase adjustment trimmer cap as shown above. When it is nulled out as much as can be done, the remainder of the nulling must be done in software. Rocky is especially good at this as it automatically starts to try to null out images of strong signals. I like PowerSDR better, but there are amplitude and phase adjustments that allow the signal to be nulled out to nothing. I suggest reading the PowerSDR manual to find out how to set up the software to run in a “softrock” compatible mode, how to set the softrock fixed frequency, and how to calibrate the signal strength when using a calibrated signal source such as the XG1 and XG2 from Elecraft.

## **Operating the Firefly SDR**

I am not sure what to say here. There is a manual on the Flex Radio web site that describes how to tune using the SDR software. First I suggest practicing tuning in signals on the band. My favorite two tuning modes are point and click & drag and drop. Using point and click, placing the cursor in the spectrum window and right clicking on the mouse will turn on cross hairs. Right clicking will toggle this cross hair mode on and off. With the cross hairs on, left clicking on a signal will place it in the middle of the receiver passband. With drag and drop, you can use the left mouse button to “drag” a signal into the middle of the receiver passband.

When you get to the point of wanting to answer a signal on the air, turn the “spot” switch on and you will be able to see the transmit signal as you turn the TX tune knob. Tune the TX spot signal and you will be able to visually place it right on top of the signal you are listening to. At that point, the transmitter is set up and ready to go. Turn off the TX spot switch and use the keyer paddles to communicate with the other end.

The monitor speaker output provides up to 1w of audio power. Thus, an amplified speaker is not needed. The on board 5K trimmer resistor (R8) in the keyer/cw sidetone monitor amplifier section is the volume control for the output level of this output. Set the volume to a comfortable level. There is no transmit connection into the SDR software, so the SDR receiver is still “on” during transmit even though the actual receiver hardware is turned off during transmit. Thus the SDR receiver produces anomalous audio output during transmit, it sounds kind of like a “thump”, so the CW sidetone output on the separate side tone monitor speaker is used to overcome the noise of the SDR receiver during the transmit period.



Note that you have *two speaker outputs*, one set from the PC that carries the *SDR receiver output*, and a separate speaker output for *cw side tone*.

The Firefly SDR has a built in keyer, complete with a memory function. The instruction on using the keyer and all of its functions are at the end of this document. If you never want to bother with the memory functions, or the beacon mode, or changing the keyer side tone frequency, just plug in a paddle and go. The only thing you really need to know is how to use the cw speed control on the front panel.

The keyer has a straight key mode where a straight key (or an external keyer) can be plugged into the transceiver. When the transceiver is turned on, the keyer chip looks to see if one side of the paddle is grounded (like what would happen with a mono straight key plug), and the keyer will enter straight key mode. If you want to use paddles again, simple power off the rig and turn it on again to clear out straight key mode.

The keyer also has a handy “tune” mode. Hold both the dot and dash paddles closed for five alternating dots and dashes and the transmitter will go into a steady transmit. Pressing either paddle will cancel the tune mode.

Read the keyer operating section. There are lots of neat things that this keyer can do.

## **Firefly SDR Customizations and Optimizations**

The gain of the audio pre-amplifiers is currently set by the resistors R7 and R12 (33K). The input impedance is essentially 300 ohms, so the gain of the op-amp is  $33000/300 = 110x$ . In addition, the fact that the op-amp is operated in a differential mode, thus there is a hidden additional 2x gain for a total of 220x.

This translates to a db gain of  $20 * \log_{10}(220) = 46.8$  db. This amount of gain was used in order to maximize the sensitivity of the receiver. As it is, the noise floor of my Presonus Firebox increases by only 2 db as I power up the receiver. The current 3 db rise, 500 Hz sensitivity is around -127 to -128 dbm when measured using the Firebox “sound card”.

However, on 30m this sensitivity level is excessive. The SDR software measures the 20m background noise at about -100 dbm at my suburban location. From a receiver performance perspective, it is good to have the receiver noise floor 10 to 15 db lower than the band noise. Thus, for my and my band conditions at my location using my 500 ft loop antenna, I have roughly 12 db too much gain in my receiver front end.

This excess gain will vary significantly from sound card to sound card. Thus, for your sound card, the background noise of the receiver in a 500 Hz bandwidth can be measured with the receiver connected to a 50 ohm dummy load. This noise level can be compared to the band noise on 30m under good band conditions to see the difference. If your sound card is less sensitive, and the difference is less than 15 db, there is no reason to change anything.

However, if like me, you see a difference significantly larger than 15 db, it may be worth while to reduce the gain of the receiver. The very best way to do this *is not* to reduce the gain of the receiver op-amp by reducing the 33K feedback resistors. The best way is to change the attenuator in the front end of the receiver. This affects resistors R1 & R2 (300 ohms) and R4 (18 ohms). The input attenuator is currently 3 db. Increasing this attenuation (rather than reducing the op-amp gain) will not only reduce the signal out of the op-amp, but will also reduce the signal at the detector, making it behave better, and also reduce the signal at the input to the op-amp, helping it behave better. In addition, the extra attenuation will serve to further decouple the receiver pre-selector filter from the detector input, allowing for a flatter, more uniform wideband image rejection response. Thus changing the input attenuator to the receiver is the preferred means of reducing overall receiver gain than reducing the op-amp gain.

Below is a list of resistor values for different attenuator values:

Attenuation	R1 & R2	R4	Rx		Attenuation	R1 & R2	R4	Rx
3	300	18	-		9	107	63	166
4	220	24	825		10	98	72	145
5	182	31	462		15	73	139	96
6	153	38	312		20	62	252	78
7	133	46	239		25	57	452	70
8	118	54	194		30	54	805	66

Figure 89. Pi Attenuator values – 3 db to 30 db

If you want to change to a higher value of attenuator, R2 and R4 can be readily replaced since they are on the top side. However, R1 is on the bottom side of the board. Rather than remove R1, the value of Rx can be applied instead to the top side as shown in the figure below:

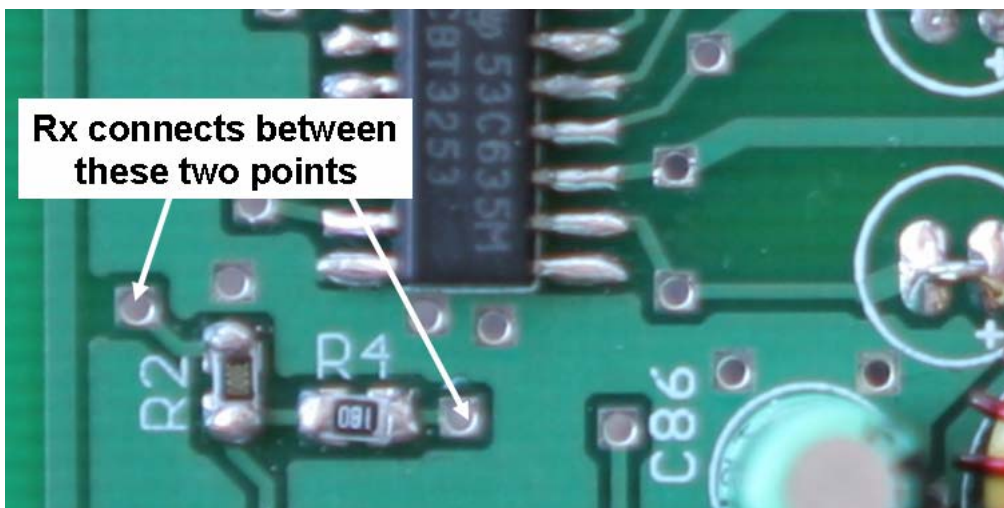
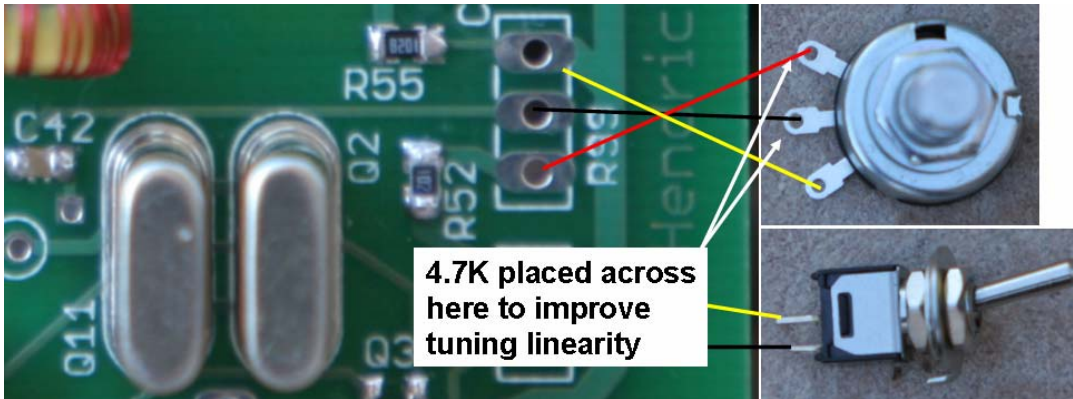

Figure 90. If the input attenuator is increased, Rx can be placed across the above 2 points, keeping R1 as is.

In order to get exactly the attenuation desired, the resistors are very odd values. However, there is no real gain to being so precise. I suggested using the 5% value that is closest to that listed above. This will be good enough.

There are two other customizations that can be done. First, the tuning range is fairly non-linear. The tuning range can be made more linear by adding a 4.7K resistor across the VXO tuning pot (R99) as shown below:



**Figure 91. Tx VXO tuning linearity improved by using an external 4.7K resistor**

The second customization is to add a small 5k trim pot to one end of R99 is the bottom end of the tuning range goes below 10.100 MHz with your crystals. In my v1.0 board, the bottom end of the tuning range was 10.092 KHz. The v1.1 board bottom end range was 10.102 MHz. This difference in tuning range is primarily due to the differences in crystals between the two boards. If the bottom end of the tuning range is significantly below 10.100 MHz, then it would be advantageous to add a small trim pot between R52 and its connection to R99, the TX VXO tuning pot. This trim pot can then be adjusted so that the bottom end of the TX VXO stops at 10.100 MHz with the spot switch turned on. This will allow the entire tuning range of R99 to tune useful coverage range, making the TX VXO easier to tune.

One more modification: The power output on 30m can be raised from 2.5w to 3.5w by adding a 47 pf disc cap at the C14 location as shown in the PA section above. This both increases the power and reduces the second harmonic.

## Appendix A. Parts List

Part	Value	Package	Part	Value	Package
C1	100 uf	E-025X065	IC1	LT6231	SO08
C2	0.01 uf	C0805	IC2	LM386-N4	LM386
C3	0.01 uf	C0805	T3	78L06	78LXX
C4	150 pf	C0805	IC6	74AHC04D	SO14
C5	0.1 uf	C0805	IC7	74AC00D	SO14
C6	150 pf	C0805	IC8	12F629	DIL8
C7	0.01 uf	C0805	IC9	74CBT3253D	SO16
C8	0.01 uf	C0805	IC11	7805T	TO220H
C9	0 pf	C0805			
C10	0 pf	C0805	Q3	BSS123	SOT23
C11	0.1 uf	C0805	Q4	BSS123	SOT23
C12	0.1 uf	C0805	Q5	FDN335	SOT23
C13	100 uf	E-025X065	Q6	BS170	SOT54E
C31	0.1 uf	C0805	Q7	BS170	SOT54E
C32	47 pf	C0805	Q8	BSS123	SOT23
C34	50 pf	trim cap	Q10	BS170	SOT54E
C35	0.1 uf	C0805			
C36	5 pf	C0805	R1	300	M0805
C40	22 pf	C0805	R2	300	M0805
C41	5 pf	C0805	R3	100	M0805
C42	0.1 uf	C0805	R4	18	M0805
C43	0.1 uf	C0805	R5	18	M0805
C44	0.1 uf	C0805	R6	18	M0805
C45	0.1 uf	C0805	R7	33k	M0805
C50	0 pf	C0805	R8	5K trim pot	3318_TRIMMER
C51	0 pf	C0805	R12	33k	M0805
C52	0 pf	C0805	R15	100	M0805
C53	0 pf	C0805	R32	1k	M0805
C54	0.1 uf	C0805	R33	1k	M0805
C55	0.1 uf	C0805	R34	3.3k	M0805
C56	0.1 uf	C0805	R35	100k	M0805
C57	0.1 uf	C0805	R36	100k	M0805
C58	0.01 uf	C0805	R37	1k	M0805
C59	0.01 uf	C0805	R38	3.3k	M0805
C60	0.01 uf	C0805	R39	1k	M0805
C62	0.01 uf	C0805	R40	100k	M0805
C63	0.01 uf	C0805	R42	100k	M0805
C64	0.1 uf	C0805	R43	100k	M0805
C65	0.1 uf	C0805	R44	75k	M0805
C68	0.1 uf	C0805	R45	75k	M0805
C69	0.01 uf	C0805	R46	75k	M0805
C70	0.01 uf	C0805	R47	75k	M0805
C71	0.1 uf	C0805	R48	8.2k	M0805
C73	100 uf	E-025X065	R49	75k	M0805
C75	50 pf	trim cap	R50	47k	M0805



C77	0.1 uf	C0805	R52	1k	M0805
C78	0.1 uf	C0805	R55	8.2k	M0805
C80	0 pf	C0805	R56	1k	M0805
C83	0.1 uf	C0805	R58	1k	M0805
C84	0.1 uf	C0805	R59	3.3k	M0805
C85	0.1 uf	C0805	R60	3.3k	M0805
C86	22 uf	E-020X050	R67	3.3k	M0805
C87	50 pf	trim cap	R68	3.3k	M0805
C88	0 pf	C0805	R69	3.3k	M0805
C91	0.1 uf	C0805	R71	3.3k	M0805
C92	0.1 uf	C0805	R72	3.3k	M0805
C94	0.1 uf	C0805	R98	100K	front panel
C95	0.1 uf	C0805	R99	10k	front panel
D1	49v Zener	SOD123			
D2	MV209	SOT54H	T1	2N4401	TO92-CBE
D3	1N4148	DO35-10	T2	2N4401	TO92-CBE
D7	SB320	DO201-15			

Figure 92. Common, non-band specific part

Part	30m	20m	17m	15m
C29	100 pf	68 pf		
C37	100 pf	68 pf		
C30	180 pf	150 pf		
C38	180 pf	150 pf		
C33	22 pf	27 pf		
C79	47 pf	33 pf		
C89	150 pf	100 pf		
C90	7.5 pf	5 pf		
C81	180 pf	120 pf		
C46	180 pf	150 pf		
C47	470 pf	330 pf		
C48	470 pf	330 pf		
C49	180 pf	150 pf		
C14	-	47 pf		
L1 - T37-6	56T #32	40T #32		
L2 molded choke	10 uH	4.7 uH		
L4 - FT37-43	10T #26	8T #26		
L5 - T37-6	16T #26	13T #26		
L6 - T37-6	18T #26	14T #26		
L7 - T37-6	16T #26	13T #26		
L9 - T37-6	19T #26 & 4T #32	15T #26 & 3T #32		
L10 - T37-6	18T #26	15T #26		
Q1	10.116 MHz	14.060 MHz		
Q2	10.116 MHz	14.060 MHz		
Q11	10.116 MHz	14.060 MHz		

Figure 93. Band specific parts

## Appendix B. Keyer Instructions

### Operation:

General notes on using the dit, dah and mem switch to control the keyer: The switch on pin 4 of the keyer chip will be referred to as the mem switch. Multiple functions result from multiple switch-press combinations (mem alone, mem+dit, mem+dah, mem+both dit and dah). Also, the switches can be pressed and released (PAR) OR pressed and held for two seconds (PAH). This doubles the number of combinations of the three control switches.

Generally, PAR is used for actions: send the code speed or send a memory. PAH is used for settings: change the code speed (no pot) or record a memory or change the iambic mode.

4 menus are used for setting various options - they are activated by a PAH of the mem switch alone or plus a simulpress of dit or dah or both. The menu selections are made by pressing either the dit or dah switches - you will then normally hear a corresponding dit or dah via the sidetone, the selection will be made and you are then returned back to normal keyer mode. In general, the operator can skip a menu item by a PAR of the mem switch.

Note that the keyer sidetone will be lower in pitch (about 270 Hz) for keyer commands such as the menu prompts. The normal sidetone pitch for routine sending defaults higher at about 580 Hz and can be changed with the SS menu command.

keys used	PAR (press and release)	PAH (press and hold)
mem switch	send memory 3	record memory 3, O?, also beacon items: BE and BA
mem + dit	send speed	paddle set of speed, pot options, main menu
mem + dah	send memory 2	record memory 2: M?
mem + both	send memory 1	record memory 1: T?

Figure 94. A Function Table of the Keypress Combinations

### Powerup:

After powerup the keyer will send an FB through the sidetone to signal correct operation. If either the dit or dah input is pressed during powerup the opposite paddle input will act as a straight key. An easy way to do this is to plug in a mono plug from the external key or keyer cable into the stereo paddle jack of the NC2030. The ring contact of the paddle jack will then be grounded.

### Speed Readout:

The speed (in WPM) will be played through the sidetone if the mem switch is simulpressed with the dit switch and then both are released. I normally press the mem switch first and hold it, press the dit switch and finally release both.

### Speed Control and Menu:

Initially the keyer will powerup at a default speed of 16 WPM in paddle speed set mode. The speed can be adjusted by pressing and holding the mem switch along with the dit switch. Usually I press and hold

{PAH} the mem switch and then tap the dit switch. After 2 seconds, the keyer will send an S (for speed set). Press the mem switch to advance to the next menu item without changing the speed. Or, pressing the dit switch will increase the speed by 1 WPM and send a dit. Pressing the dah switch will decrease the speed by 1 WPM and send a dah. You can continuously adjust the speed by holding either switch but note that if you run the keyer "off the scale" at either 8 or 49 WPM, the keyer will "wrap around" to the opposite speed extreme. Exit the speed adjust routine by pressing and releasing the mem switch.

If the pot circuitry is connected AND the P menu is invoked to turn on the pot speed control the speed can be adjusted by turning the pot. Maximum possible speed is 49 WPM, minimum possible speed is 8 WPM. Note that the minimum speed can be affected by component tolerances on the speed pot and the capacitor - see the pot calibration menu item if an 8 WPM minimum speed is required. The pot position is read continuously when the keyer is sending code, just before each dit, dah or space is sent. This allows the operator to adjust the code speed even in the middle of a memory send or record.

	Menu item	pressing a dit:	pressing a dah:
S	Speed set from paddle	increases speed by 1 WPM	decreases speed by 1 WPM
P	Pot / paddle speed control	selects pot speed control	selects paddle speed control
C	Calibrate pot speed control	enters the calibration routine	restores default pot calibration
B	Bug / straight key mode	enables bug mode (dah = key)	disables bug mode (default)
A	iambic mode A or B	enables iambic mode A	enables mode B (default)
R	Reverse paddle mode	reverse dit and dah switches	return dit and dah to normal
AU	Autospace on / off	turns on character autospace	turns off autospace (default)

Figure 95. Mem + dit menu (PAR mem to advance to the next menu item)

**P - Select Pot or Paddle speed control:**

Allows the keyer to be switched between pot or paddle speed control. The keyer defaults to paddle speed control.

**C - Calibrating the Pot speed control:**

Due to the variation in capacitors and pots it is likely that the minimum setting of the pot will result in a minimum speed higher than 8 WPM. This menu item will compensate and store an updated calibration value. Before entering the menu, be sure to turn the pot to the minimum speed. Then press the dit to go into the calibration routine - then one or more dits will be sent after a short delay and the keyer will exit from the menu. If the pot calibration is run with the pot not set at the minimum, rerun the cal with the pot correctly set. Pressing a Dah will restore the default powerup calibration value.

**B - Bug / Straight-key mode:**

Dits are sent normally but dahs are sent like a straight key.

**A - Iambic mode A or B:**

The A mentioned above signifies the mode A/B select menu item. The iambic mode of the keyer can be set to either mode using this routine. Check the JHP web site for an Acrobat (.pdf) file which explains the difference between the A and B keying modes.

### **R - Reverse paddle mode:**

Reverses the dit and dah switches (easier than resoldering a jack). Remember that the pot speed control will be changed to the dit paddle which means that pot speed control changes while the dit is pressed will be ignored until the dit is released.

### **AU - AUtospace on/off:**

The autospace feature inserts a character space (1 dah in length) automatically if the operator has not pressed a paddle switch 1 dit space after the last dit/dah sent. This feature is always on in the memory record routines (needed for the recording process).

### **Recording Memory 2:**

A memory of up to 40 characters long can be recorded. The memory 2 record menu is entered by simulpressing the memory and the dah keys and holding them for 2 seconds. I usually PAH the mem switch and then tap the dah key.

	Menu item	Pressing a dit:	Pressing a Dah
SS?	Sidetone Set	Lowers sidetone	Raises sidetone
M?	Record memory	records a dit	records a dah

Figure 96. Mem + dah menu (PAR mem to exit)

### **SS? - Sidetone Set:**

Press either a dit or dah to enter the SS menu and turn on the sidetone. A dit PAR (or PAH) will decrease the sidetone frequency, a dah PAR (or PAH) will increase the sidetone frequency. The sidetone will "wraparound" at the high (about 1700 Hz) and low (about 320 Hz) frequency limits. When the sidetone is at the desired frequency a PAR of the mem switch will exit the menu and store the new sidetone frequency in EEPROM. The SS menu item affects only the normal sidetone, the command sidetone is unchanged.

### **M? - Record Memory 2:**

The memory is recorded by sending normally. Note that the keyer output is off during the recording and that the lower command sidetone is used. When complete, PAR the mem switch. The routine will be exited automatically after the 40th character is sent. The memory is saved in flash memory which means that it will still be there even if power is removed. If this menu item is entered by mistake, PAR the mem switch to exit without changing the memory.

### **Playing Memory 2:**



Play memory 2 by simulpressing and releasing the memory and the dah keys. I usually PAH the mem switch and then tap the dah switch - the memory starts to play after the mem switch is released. A tap of either the dit or dah switch will stop the message play.

	Menu item	pressing a dit:	pressing a dah:
BE	BEacon mode	starts the beacon going	Exits the menu
O?	Record memory 3	records a dit	records a dah
BA	Beacon Alternate mode	selects alternate beacon sends of mem 1 and mem 2	selects send of mem 1 only (default)
ST	SideTone on/off	turns off the sidetone	turns the sidetone on (default)

Figure 97. Mem switch menu (PAR mem to advance to the next menu item)

**BE - Beacon Mode:**

Beacon mode will send the contents of mem 1 continuously. Start the beacon by pressing the dit switch - the beacon starts to play. Exit beacon mode by tapping the dit or dah switch.

**O? - Record Memory 3:**

The memory is recorded by sending normally. Note that the keyer output is off during the recording and that the lower command sidetone is used. When complete, PAR the mem switch. The routine will be exited automatically after the 40th character is sent. The memory is saved in flash memory which means that it will still be there even if power is removed. If this menu item is entered by mistake, PAR the mem switch to exit without changing the memory.

**Playing Memory 3:**

Play memory 3 with a PAR of the memory switch. - the memory starts to play after the mem switch is released. A tap of either the dit or dah switch will stop the message play.

**BA - Beacon Alternate between mem 1 and mem 2 mode:**

This routine selects/deselects alternating the beacon play between memory 1 and memory 2.

**ST - SideTone on/off:**

*Since most rigs have a built-in sidetone, it is handy to be able to silence the NorCal Keyer sidetone, especially when the tone is injected into the rig audio. Note that the sidetone will still be engaged during any menu or recording entry even if it has been turned off.*

	Menu item	pressing a dit:	pressing a dah:
T?	Record memory 1	records a dit	records a dah

Figure 98. Mem + both menu (PAR mem to exit)

**T? - Record Memory 1:**

Enter record mode for memory 1 with a PAH of the mem switch and both paddle switches for 2 seconds. Hold the mem switch down, then squeeze both paddle switches simultaneously (they both must be down at the same time), then release the paddle, keep holding the mem switch until after 2 seconds the keyer will send **T?**. Memory 1 can now be recorded. Start sending your message. when complete, press the mem key. The memory is 40 characters long - recording will terminate automatically after the 40th character. If this menu item is entered accidentally, just PAR the mem switch to exit without recording.

### **Playing Memory 1:**

First, hold the mem switch down, next, squeeze both paddle switches (they both must be down at the same time) then release the paddle and finally release the mem switch before 2 seconds elapse. The memory will start to play right after the mem switch release.

### **Notes:**

To perform a full keyer reset (parameters to their default values, memories untouched):

- 1) remove power to the keyer
- 2) press and hold the mem switch
- 3) powerup the keyer keeping the switch depressed until the FB is sent.

One unique feature of the NorCal Keyer is 5 ditdah tune mode. If both paddles are held for at least 5 ditdahs and then released, the keyer will enter tune mode (key down, sidetone on). To exit, tap either the dit or dah. Thanks to Lew Paceley, N5ZE, for inventing this mode.